



KPMA Gravity Concentrate Upgrading Research Program: Grinding For Gold



By: Randy Clarkson, P.Eng. and Gavin Clarkson B.Sc.

March 31, 2015



NEW ERA Engineering Corporation

Placer Mining and Small Hydro Specialists

71 Fireweed Drive, Whitehorse, Yukon, Canada Y1A 5T8, 867-668-3978

1 - Summary and Conclusions:

The objectives of this field and laboratory research program were to determine the best simple methods and equipment for upgrading various types of sluicebox concentrates to a saleable product, to optimize primary recovery of placer gold in sluiceboxes and to compare to previous research which used radiotracers.

Sluiceboxes provide a much higher concentration ratio (between 20,000:1 and 50,000:1) than any other gravity concentrators such as jigs and spirals, (figures 20 & 21). Sluices are also very reliable, inexpensive and simple to operate and were estimated to recover 95% of the gravity recoverable gold during radiotracer testing and research by Clarkson (1989-2010 – Section 8). During the 2013 and 2014 field seasons a total of 23 sluiceboxes were tested this time using conventional sampling methods. Large 0.5 to 2.0 cubic meter samples were processed on the author's testing sluice and in the UAF laboratory. Average gold recovery for all operations except three sites was over 99% of gravity recoverable gold (Section 13). These results confirmed the earlier more conservative gold recovery estimates derived from radiotracer testing.

The lowest gold losses occurred at sites employing a section of expanded metal riffles held tightly over unbacked Nomad matting and at least 3.6 m (12 feet) in length in combination with a narrower sluice run fitted with one inch angle iron at least 2.5 m (8 feet) long with sections of slick plate between the riffle sections. Some operators used a wider 2.5 m (8 feet) length of hydraulic riffles at the same width as the expanded metal run instead of the one inch angle riffles, (see appendix 3 for recommendations).

Three operations had gold losses as high as 14% due to combinations of high clay, poor riffle design, surging feed and/or the use of untested alternative primary gold recovery systems. After retrofitting at the three operations, the gold losses were reduced to less than 1% except at the reverse spiral drum system where gold losses were lowered to 2.4%. This 2.4% loss is an improvement but is about three times that of the other conventional sluicebox systems. See Section 13 and figures 61-67 for further details.

Secondary upgrading of sluicebox concentrates in the Yukon is done primarily with small sluices (long toms), dual cell hydraulic jigs, live bottom sluices, or a combination of any two (figures 22-27). Conventional long toms operating at optimum values had the lowest gold losses (tailings at from 0.07 to 2 fine grams/m³ – Section 14). Long toms can produce greater volumes of concentrates but are simple and effective when operated with sufficient water volume and velocity.

The dual cell jig tailings tested had from 5 to 55 fine grams/m³ mostly due to the loss of fine (-50 mesh [#] gold). Most jigs have long toms to catch the gold lost in their tailings but the long toms were usually not operating at optimum values and/or were cleaned very infrequently. Live bottom (Lizotte) sluices produced very clean gold concentrates at their first riffles but the ones tested also had the highest losses (up to 200 fine grams/m³ in their tailings) mostly due to the inability of their elutriator to recover coarse gold. See Section 14 for details.

Almost all of the concentrates tested in the laboratory and 2014 pilot scale test program were difficult concentrates which the miners involved were unable to upgrade to clean raw gold. The difficult concentrates consisted of 2nd hutch cleanup jig concentrates and tailings from cleanup jigs, cleanup long toms, gold wheels, Deister tables, hand sorting, magnetics, cemented concentrates and smelter slag. Some test sluice tailings

and gold pan tailings were also tabled to determine losses of upgrading these concentrates in the field.

In 2013 and 2014 a total of 35 shaking table tests were conducted with the majority on the University of Alaska (UAF) Gemini table in the lab (figure 32). All shaking table tests in the field were done with the Keene table (figure 33). The Keene ST1 shaker table was about 10 times cheaper than either the Gemini or Deister to buy at a cost of about US\$3,000. The Keene table also had a series of rotating magnets under its deck and doubled as a very efficient magnetic separator for placer gold concentrates during field trials. The Keene table was used in the field to pre-concentrate samples prior to grinding in a rod mill. The ratio of concentration ranged from 1:1 to 20:1. This greatly reduced the amount of samples that had to be ground and screened.

It was virtually impossible for shaking tables to obtain a high percentage of clean gold from these difficult concentrates with abundant garnet, cassiterite, galena and hematite. The main issue with tabling the difficult concentrates was that the coarser (+30#) flat gold particles would “surf” over the beds of compacted high density gangue minerals and end up in the table middlings or tailings. Often the -50# or -100# concentrates would table better than the coarser concentrates. When these fine concentrates were ground in a rod mill the fine gold particles became flatter and usually were easy to recover and clean on any shaking table. See Section 15 for details.

A small jig test was conducted on 10 kg of cassiterite abundant concentrate but the test results were dismal with only about 31% of the salted gold particles ending up in the jig concentrates. Jigs are very time consuming to prepare for and to clean up after each test run.

Several tests were performed to separate out gold from the magnetics previously separated with hand magnets at the mines. The results of testing with a low intensity magnetic drum separator (figure 56) were disappointing with lots of magnetic material reporting with the non-magnetic material and vice versa. However the Keene table worked very well at separating the previously entrained gold particles from the magnetics. This is due to the combined shaking action of the table and the rotating magnets under the table. The Keene table was a much faster, easier and more reliable method of separating out gold from magnetic materials and did not require drying of the sample (see Section 15 for more details).

A total of 29 grinding tests were undertaken. A rod mill was chosen for grinding the concentrates due to the combination of impact and shear forces from the rolling rods which could produce coarse flattened gold and fine gangue (waste minerals) (figures 1 & 2). Rod mills are simple and easy to construct and maintain, and are easy to clean between tests. Concentrates containing abundant heavy minerals such as garnet, galena, cassiterite, and magnetite/ hematite/ ilmenite which could not be separated by tabling, jigging, panning or other physical methods were ground in a 200mm (8”) diameter rod mill operating at 75-80% critical speed for 6 to 9 minutes.

Some success was achieved with the first 7 grinding tests but it was only when the weight of the samples was reduced from 2 kg to 1 kg that the results improved dramatically and the gold particles were flattened instead of ground. Clean raw +50# gold recoveries generally rose from 31-35% to 71-78% in the lab with 1 kg sample weights. It would appear that the presence of too many waste minerals caused the gold particles to abrade. In field testing when a longer (300 mm – 12”) mill was used the results were even better with clean raw gold recoveries as high as 99% (in garnet), 95% (in galena) and 86% (in cassiterite) (figure 3). In addition, in most cases the newly

ground -50# pulps could be tabled using the Keene table to a lower grade concentrate suitable for direct sale or for blending into the higher grade concentrates.

The -50# cassiterite ground products were reground for 2-4 minutes, clean raw gold was recovered on 50, 70 and 100# sieves. The finer gold particles were flattened by the grinding action and many were caught on the same 50# they passed through prior to grinding. The second grind raised the overall clean gold recovery to 94-97%.

Figures 1 & 2 – Gold Sample Before and After Grinding in a Rod Mill.

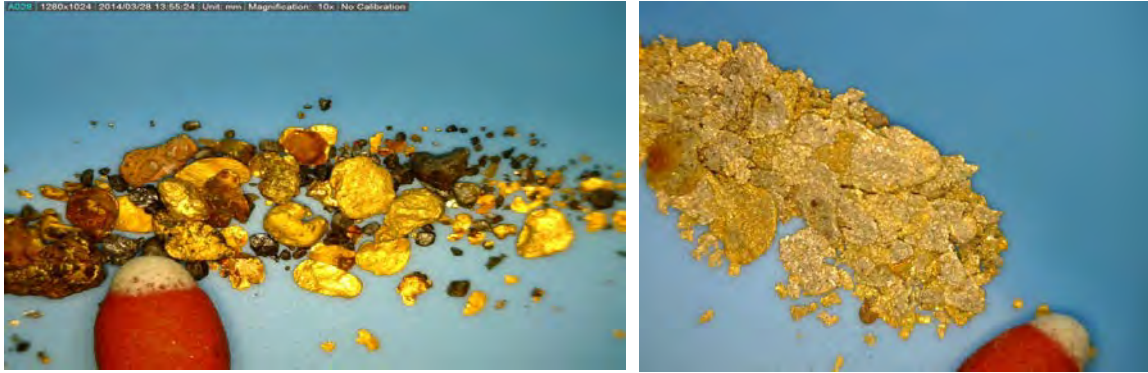
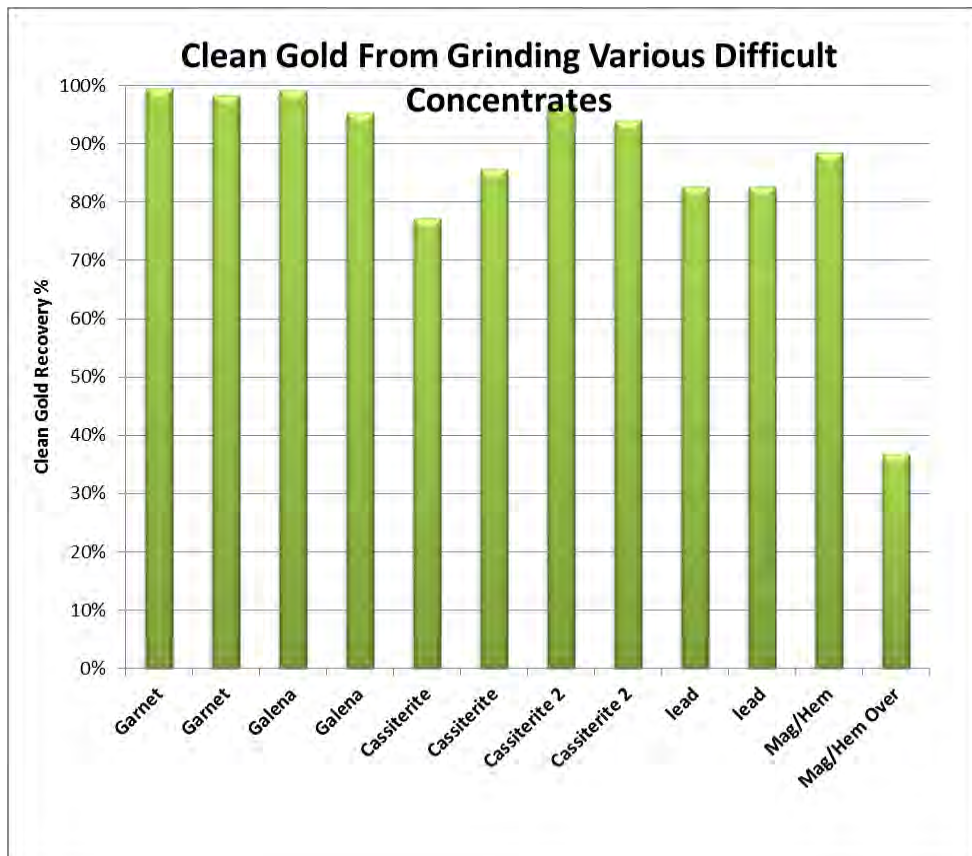

Figure 3 - Summary of Clean Gold Recovery from Various Difficult Concentrates.



Note: Cassiterite 2 refers to the combined clean raw gold recovery after a second grind and sieving of the -50# material from the first grind tests. More testing with smaller samples would probably improve clean raw gold recovery of the magnetite hematite concentrates. The last bar is from a sample that was over ground.

Table of Contents:

1 - Summary and Conclusions.....02

2 - Acknowledgements.....06

3 - About the Authors.....06

4 - Objectives.....07

5 - Background: The Yukon Placer Mining Industry.....07

6 - Background: Properties of Gold.....10

7 - Background: Selection of Grinding Equipment.....11

8 - Background: Sluicboxes.....15

9 - Background: Upgrading Sluicbox Concentrates.....16

10 - Background: Previous Research.....21

11 - Field Testing Methodology.....24

12 - Laboratory Testing Methodology.....26

13 - Field Program Results – Sluicbox Testing.....29

14 - Field Program Results – Cleanup Concentrates.....33

15 - Laboratory and 2014 Pilot Scale Test Program Results.....34

16 – References.....43

APPENDIX 1 - Summary of Data from Shaker Table Tests.....45

APPENDIX 2 - Summary of Data from Grinding Tests.....47

APPENDIX 3 - Sluicbox Design and Operating Parameters.....50

APPENDIX 4 – Recommended Difficult Concentrate (Middlings) Upgrading.....53

APPENDIX 5 - Feeder for Keene ST1 Shaking Table.....54

APPENDIX 6 - Specifications for Fabricating & Operating Pilot Scale Rod Mills.....55

APPENDIX 7 - Acknowledgement of Funding.....56

2 - Acknowledgements:

This research project could not have been completed without the funding from the following three agencies: Canadian Northern Economic Development Agency; Strategic Investments in Northern Economic Development; and Yukon Research Center.

The authors gratefully acknowledge the guidance and technical assistance of Daniel Walsh: P.E. and Emeritus Professor of Mineral Preparation (University of Alaska, Fairbanks); Professor Walsh is a well-known expert in placer gold recovery; he assisted during the first week of the 2013 field program and led testing and research efforts at the UAF laboratory. They also acknowledge the Yukon Geological Survey; and the participating Yukon placer miners who trusted the authors with their precious concentrates and provided their generous hospitality and assistance to the authors.

3 - About the Authors:

Randy Clarkson P.Eng. is a professional mining engineer registered in the Yukon and British Columbia who has been working out of Whitehorse Yukon Territory since 1980 on placer, lode mining and small hydro projects. He has over thirty years of diversified experience in mining, engineering at several locations worldwide. Randy is best known for the development of an innovative technique using radioactive gold particles as tracers to assess the real efficiency of various gold recovery and sampling systems. He is also the author of several publications/seminars on placer exploration, sampling, gold recovery and mining systems.

Figure 4 – This is an older photo of Randy Clarkson sorting out radiotracers from gold concentrates with a scintillometer and brush to assess the gold recovery efficiency of sluiceboxes (1989-2002).



Gavin Clarkson has a B.Sc. in geology from Simon Fraser University and is currently completing his Masters of Mining Engineering at the University of British Columbia.

Figure 5 - Gavin Clarkson has extensive field experience in placer sampling and a good sense of humor.

4 - Objectives:

To determine the best simple methods and equipment for upgrading various types of sluicelox concentrates to a saleable product.

Also to optimize primary recovery of placer gold in sluiceloxes and to compare to previous research.

Figure 6 - Don't we all wish it could be that easy!

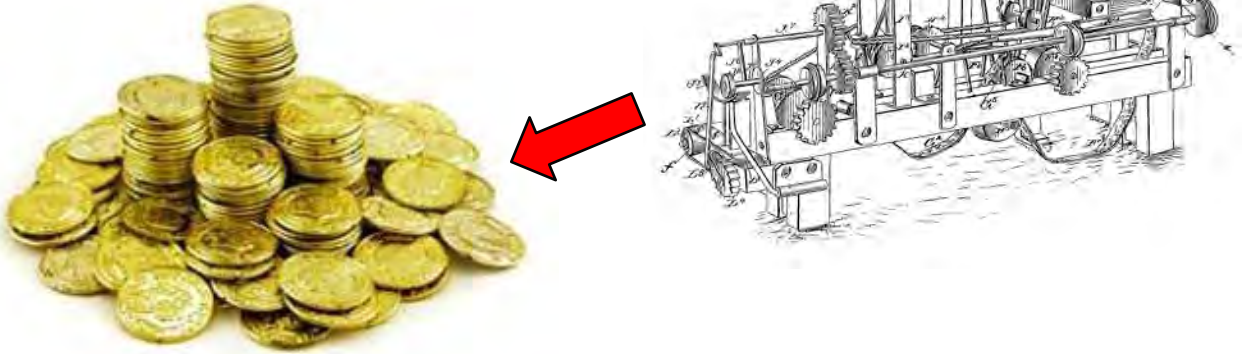

Extensive field testing of sluiceloxes has not been conducted in the Yukon since 1990 when they were assessed and optimized using radio-activated gold as tracers (Clarkson 1989, 1990, 1996 & 2010). Applied research using on-site and metallurgical laboratory testing is required to determine the most cost and time efficient methods for upgrading sluicelox concentrates using gravity, magnetic, electromagnetic and other physical methods. Laboratory and field scale testing should be conducted on placer concentrates to test equipment and develop detailed methodologies for upgrading various types of concentrates.

5 - Background: The Yukon Placer Mining Industry

Placer mining has been a cornerstone of the Yukon's economy and modern culture since the great Klondike Gold Rush of 1898. Placer mining is responsible for the accelerated early development of northwestern Canada. Much of the Yukon's transportation infrastructure can be attributed to early placer mining. The industry has been the Yukon's most reliable generator of economic wealth and has continued unabated through the great depression of the 1930's and recent economic recessions. In recent years placer mines have often been the only operating mines in the Yukon.

Currently there are over 100 family based placer mines with a combined gross income in excess of \$60 million annually. Spin off benefits to the local economy are in the order of 2.5 times that amount with local labor, purchases of fuel, equipment, parts, groceries and other supplies. Placer mining is especially vital in the Yukon's rural areas including Dawson, Mayo and Haines Junction. Most of the recent hard rock exploration "gold rush" (2010-2012 with total annual exploration at \$150 to \$300 million) to explore for lode gold mines was based on the presence of placer mining in those areas.

Typical placer mines range from small family operations to those employing a dozen workers and several of the largest available sizes of heavy equipment. Placer mines are heavy equipment intensive resource industries. The next greatest concentration of large scale heavy equipment (D10-D11 size bulldozers) would be found several hundreds of kilometers southeast in the Alberta oil sands mega projects.

Placer gold ranges in size from “flour gold” (finer than 74 microns or 200 mesh) to coarse nuggets depending on the source of the gold, size and gradient of the stream and many other factors. Placer gold particles also can range dramatically in shape from well-rounded nuggets to ultra-thin flakes to irregular or botryoidal (grape-like) particles depending on the source of the gold, size and gradient of the stream and many other factors. Sluicboxes are the primary means of concentrating the low grade alluvial gravels and can provide relatively efficient concentration (in excess of 95% recovery efficiencies) at high ratios of concentration (from 20,000:1 to 50,000:1, Clarkson 1989-2010).

These primary sluicbox concentrates must be upgraded to a purer saleable product (generally from several cubic meters of concentrate to less than a liter of gold). In the Yukon and Alaska, secondary concentration methods generally include long toms (small sluices) and dual cell hydraulic jigs, often with significant gold losses. The final concentration stage upgrades these secondary concentrates to a high purity ~ 90% raw gold concentrate suitable for direct sale or for smelting to a dore bar of gold for sale to a gold buyer. The final concentration consists of the use of screens, large diameter gold wheels/ spirals, various types of shaker tables, hand-held magnetics, hand panning and hand sorting. Magnetic minerals such as magnetite and tramp iron are removed with hand held magnets. Generally the coarser gold sizes are hand-picked. Many of the final concentration methods are very labor intensive, arduous and result in further gold losses

The tailings from both the secondary and final upgrading equipment (middlings) are often very high value and contain significant coarse flat, porous, irregular and botryoidal (grape like) -14 to +200# (mesh) gold particles. The surrounding waste minerals (gangue) consist of greater than 90% high density metallic sulphides and oxides. These high density materials do not respond to further gravity separation due to the reduced difference in specific gravity. Gangue (waste) minerals initially separated in the primary concentration by sluicboxes rarely exceed an average specific gravity of 2 to 3, whereas in secondary concentrates the overall gangue minerals density can be more than doubled to range of 6-8. Many of the secondary concentrates contain very fine “flour gold” (-74 micron, -200 mesh) or very flattened particles in a mixture of high density minerals such as galena, hematite, illmenite, magnetite, scheelite, wolframite, cassiterite, pyrites and pyrrhotites (figures 7 & 9). Despite the typical specific gravity of placer gold of approximately 19, gravity separation equipment still struggles to extract even a small percentage of gold particles from a high density mixture.

Chemical processing such as cyanide leaching or flotation are beyond either the skill set or the permitting regime of most placer miners, further processing is often limited to tedious hand picking. The mining season is short, typically less than four months, and there is a security risk in delegating such a delicate task so the stockpiling of difficult concentrates invariably outpaces processing. Often the tailings from final concentrates (middlings) are stored in buckets for years awaiting time-consuming hand sorting methods. Typical gold rooms are full of buckets and jars of these low grade middling concentrates. Storage and extended periods of hand sorting of gold concentrates also pose a security risk to placer miners.



Figure 7 - Typical Klondike Placer Gold with Various Size Distributions Shown.



Figure 8 - Today's Placer Miners Scraping the Bottom of the Barrel.



Galena



Hematite



Illmenite



Magnetite



Wolframite



Cassiterite



Pyrite



Pyrrhotite

Figure 9 - Placer gold concentrates contain gold particles as fine as -74 micron, -200 mesh) flattened particles in a mixture of high density minerals such as galena, hematite, illmenite, magnetite, scheelite, wolframite, cassiterite, pyrites and pyrrhotites. High specific gravity (S.G.) gangue minerals in concentrates make gravity separation extremely difficult. However gold is the most malleable mineral and all these other minerals (except for lead) are brittle and grind to powder.

Over its extensive mining history (130 years), Canada's Yukon Territory has adapted to mining and processing lower grade (side pay) and bench deposits with fine gold and other accessory minerals, and on reprocessing tailings from previously mined areas as the price of gold rises and higher grade materials are mined out.

Of special importance to this industry is the limitation in funding for exploration. Virtually all the Yukon placer operations are family based private enterprises, and operators rarely have the time or the finances to spend on exploration programs beyond their own producing pits. Increasing expenses and lower grade placer gold deposits all enforce the importance of maximizing gravity recoverable gold (GRG) recovery.

6 - Background: Properties of Gold

Gold is the most noble of the noble metals and one of the least reactive chemical elements. It has excellent chemical stability, and its resistance to oxidation and corrosion has led to an industrial use in heat shielding and electronics. It is unaffected by air, moisture and most corrosive reagents. It is also the most malleable of all metals.

Native or raw placer gold is actually an alloy of gold and silver with minor amounts of other metals such as copper included. In the Yukon, pure raw gold can range from 60% gold to over 90% gold with the balance mainly as silver. Gold particles range in size from several gram nuggets (often with quartz inclusions) to fine flattened gold commonly as small as 74 microns (200#) in size.

The density of native gold is about 19 which is significantly higher than most other minerals found in gravel (S.G. of 2-3) and somewhat higher than many associated sulphide and oxide minerals (S.G. of 4-8, figure 9). Gold is also one of the most malleable elements. It can be rolled and beaten to widths less than the wavelength of visible light, up to a 99.9996 % reduction of thickness (Nutting & Nuttall, 1977).

The high density and malleability makes gold very difficult to grind compared to other minerals (figures 1 & 2). The unique response of gold to mill grinding circuits is a well-known phenomenon. Its unique attributes lead to high recirculating loads in conventional hard rock mine grinding circuits, affecting its breakage, classification and liberation. Coarse gold has been found to grind 6 times slower than ore and up to 20 times slower in certain size classes, with finer gold reaching survival rates in grinding circuits of 98-99% (Laplante, Buonvino, Veltmeyer, Robitaille, & Naud, 1994). Modeling gold's behavior in grinding circuits is difficult, as not only does it require longer grinding than conventional ore, grains can be flattened or cold welded into coarser size classes or be smeared onto other minerals or mill linings (Noaparast & Laplante, 2004).

Since the malleability of gold makes it resistant to grinding, the particles are preferentially preserved when compared to brittle gangue minerals like galena, sphalerite, pyrite or hematite. These relative differences can be exploited by submitting a relatively high value concentrate to grinding and separating the pulverized gangue from the preserved particles through sieving. In order to recover the highest value of gold from a concentrate the grinding device must be able to reduce the gangue (waste) minerals to at least -50# while avoiding fragmenting the original gold particles. The flattening of gold particles is desirable because it increases its effective size on a screen and its amenability to recovery on a shaking table concentrator.

7 - Background: Selection of Grinding Equipment

Ofori-Sarpong & Amankwah, (2011), conducted a study on the response of gold grains to different grinding equipment at a lab scale. These authors wanted to understand the resulting grain shapes of gold after grinding in various equipment types (figure 11). After gold containing ore was crushed to -25 mm in a jaw crusher, the material was then dried and treated separately in a lab sized disc mill, ball mill, vibratory pulverizer and hammer mill. The resulting shapes can be seen in the following figure 10.

Figure 10 - Gold particle shape after grinding in (left to right): hammer mill, disc mill, vibratory pulverizer, ball mill (Ofori-Sarpong & Amankwah, 2011).

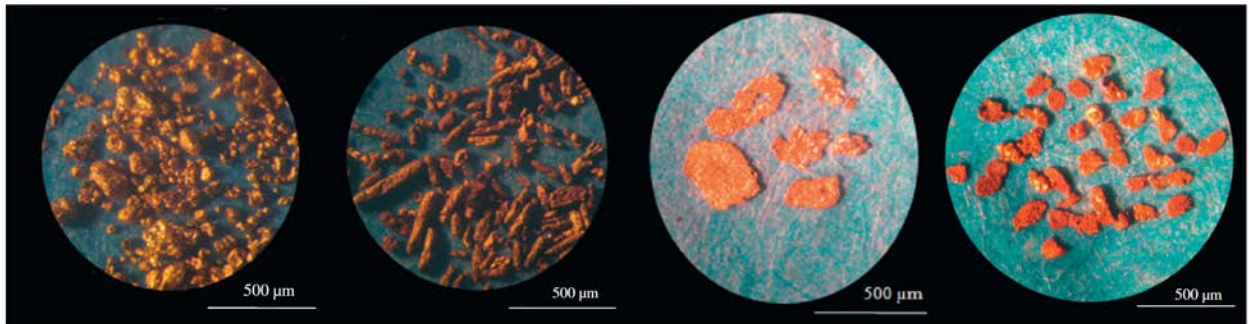
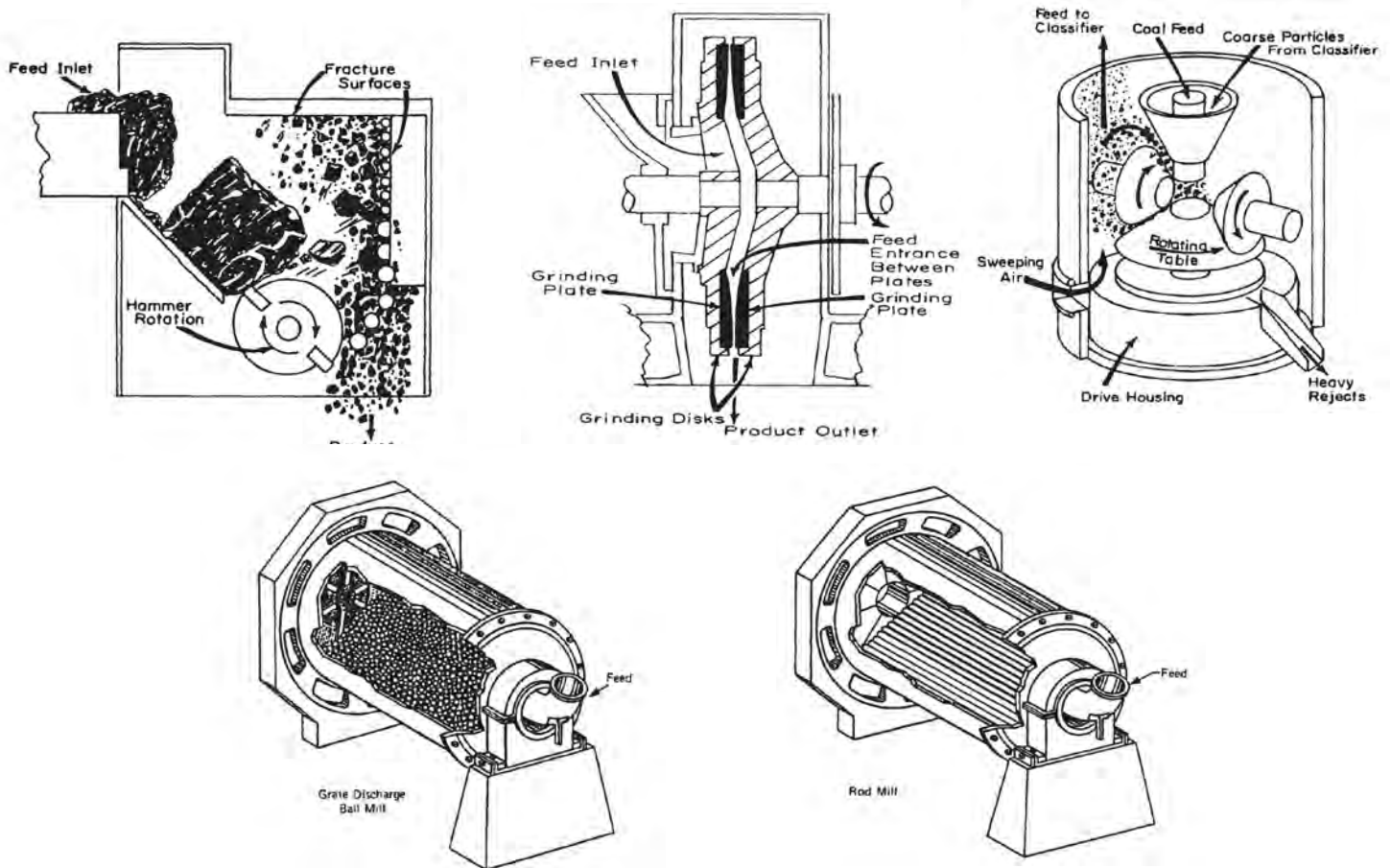
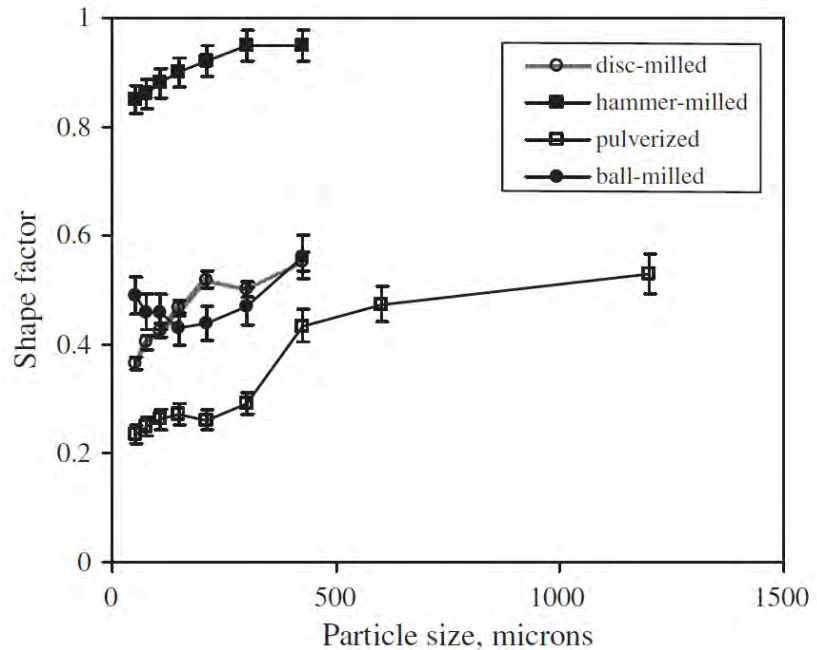

Figure 11- Different Types of Grinding Equipment (Austin & Trass, 1997).



Each piece of equipment used employs differing forces on the materials. The hammer mill employs mainly impact forces, disc mill employs shear forces, and vibratory pulverizer employs compressive forces. The ball mill employs a chaotic combination of forces, including impact, compression, chipping and abrasion (Ofori-Sarpong & Amankwah, 2011). Size analysis of the ore gangue revealed that finest gangues were produced by the vibratory pulverizer, followed by the ball mill, disc mill and coarsest grinds produced by the hammer mill. The gold particle size distribution was significantly different, with the vibratory pulverizer producing the coarsest grains which had been flattened by the dominantly compressive forces employed. The hammer mill gold grains were globular and preserved their original nugget shapes, likely having had little contact with the hammers in the tested size range. The disc mill produced cigar-shaped grains that had been rolled in the shear forces of the discs, and the ball mill produced irregular, varied shapes (figure 12).

Figure 12 - Shape factor vs. particle size for gold grains in each grinding environment. Pulverizer produces the flattest grains across all sizes (Ofori-Sarpong & Amankwah, 2011).



For the purposes of grinding and sieving for recovery, the fine gangue and coarse particles produced by the vibratory pulverizer would seem to yield the best results, followed by the flattened but finer grains produced in the ball mill. The pulverizer is not as practical of an approach due to the complexity and low capacity of the equipment. Missing from this study are the results from a rod mill, which due to the combination of impact and shear forces from the rolling rods would likely have produced coarse flattened gold and fine gangue without the complexity of the pulveriser. From the above results, the vibratory pulveriser would be the most effective at flattening and preserving gold grains for sieve capture. However, these grinders are more expensive and difficult to maintain for the average placer miner. A simpler and almost as effective device would be a ball or rod mill, as it would be easy to construct and maintain. A rod mill was chosen for field testing due to preliminary lab tests indicating better preservation of gold particles compared to ball mills as well as the ease of cleaning between tests.

The critical speed of a rod mill is the rotational speed at which the centrifugal force created by the rotation exceeds the force of gravity and all of the rods remain forced against the inside of the mill cylinder. Generally efficient grinding occurs at about 70-80% of the critical speed where the rods are carried most of the way up the sides of the mill and then cascade down to grind any solids (figure 13).

The critical speed (rpm) = $76.63 / (\text{Square Root of the Diameter in meters})$ or
= $265.45 / (\text{Square Root of the Diameter in feet})$

Figure - 13 Critical Speed of Rod and Ball Mills.

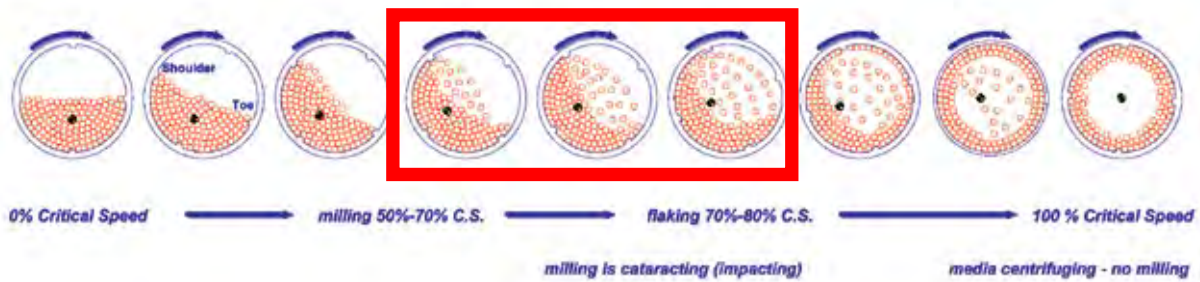

From <http://www.pauloabbe.com/size-reduction/resources/mill-speed-critical-speed>

Professor Dan Walsh introduced the concept and practice of using rod mills for upgrading placer gold concentrates to this KPMA Research Project. He has used this procedure for many years at UAF, while assisting placer miners with gold cleanups. The rod and ball mill used at the UAF laboratory in 2013 and 2014 is shown on figures 55 & 56. It required a bed of powered rollers with a speed adjustment and was perfect for lab work but not very portable or inexpensive for field testing.

The author designed a rod mill using a portable cement mixer for the 2014 field season tests (figures 14-17 & Appendix 6). The portable cement mixer had a horizontal drive with a gear box and was driven via two pulleys with an electric motor. The speed of rotation was increased by changing the sizes of the two pulleys to increase the speed from 25 rpm (typical of cement mixers) to the required 72 rpm which is the 75-80% critical speed for 200 mm (8") diameter rod mill. The 75- 80% critical speed for a larger 300 mm (12") diameter mill would be 60 rpm.

An adaptor to the horizontal drive shaft was machined and welded to a 200 mm (8 inch diameter pipe which serves as the rod mill. A lid and gasket seal was fabricated as well. The rods consist of a selection of 12 mm (1/2"), 18 mm (3/4") and 25 mm (1") diameter cold rolled steel rods cut about 12 mm (1/2") shorter than the inside of the mill. The rods should fill up about 40% of the volume of the mill.

The cement mixer also had to be able to support the loaded weight of a 200 mm (8 x12 inch) mill of 70 kg (150 lbs.). The dolly which holds the mixer drive allows the rod mill to be moved around easily and to be tipped back for loading rods, sample and water into the mill; to sit horizontal while rotating and grinding; and to be tipped forward to pour the ground slurry into a receiving basin. A small carpenter's level is used to ensure the mill is level while grinding (figures 14-17). A timer is required to ensure the mill does not run too long and overgrind the sample.

Cement mixers often are driven by a gear around the perimeter of the bowl. This type of mixer is not suitable because it would have been difficult to change the speed. The rod mill used in the field in 2013 mining season was homemade (figure 50), had only three large rods and a threaded rod through the middle of the mill. The rods were too few; too large would get tangled up on the center threaded rod. These are the reasons this design of a rod mill is not recommended.

Figures 14 -17- Gavin Clarkson and the Portable Rod Mill Designed for Field Testing.



Note: Loading the rod mill with concentrate & rods & water in the vertical position

Note: Leveling the mill prior to grinding in the horizontal position to ensure an even grinding action.

Note: The portable rod mill was constructed using a portable cement mixer on a dolly to support, rotate and allow easy movement of the heavy rod mill & rods.

The mill is tipped up for loading with rods, solids and water. It is leveled for grinding, usually 6 to 9 minutes. It can then be tipped up to remove the lid and lift out the rods for cleaning. Then the mill can be tipped forward to wash it out into a basin. Further details on the construction of the rod mills are shown in Appendix 6.

8 - Background: Sluiceboxes

The sluicebox has been used for the recovery of placer gold since ancient Grecian days (Jason's Golden Fleece) and it is still the most important placer gold concentrator in the world. Sluiceboxes provide a much higher concentration ratio than any other gravity concentrators such as jigs and spirals. Sluices are also very reliable, inexpensive and simple to operate. Pay gravels are usually washed through vibrating or rotating screen decks to separate the coarse gravels and liberate the gold particles from clay prior to sluicing.

A sluicebox is essentially a rectangular flume containing riffles on matting, through which a dilute (<12% solids by volume) slurry of water and placer gravel flows. The most common sluice riffles include expanded metal, one inch angle iron (Hungarian) and flat bar. Matting is usually placed under the riffles to help retain the gold particles. Sluiceboxes are actually centrifugal concentrators with settling velocity playing a minor role in gold recovery. Due to their higher density, gold particles tend to segregate to the bottom of the slurry flow where they form a streamline that is diverted by a low-pressure zone into a riffle. Under ideal conditions, this ribbon of slurry will be overturned as it flows down the rear of the following riffle and will continue flowing in a circular path to form a vortex. At the bottom of this vortex, centrifugal and gravitational forces combine to drive gold particles into or beside the matting (figures 18 & 19).

The slurry velocity provides the energy that powers the vortex. If the velocity of the slurry is reduced through overloading with solids, insufficient water flows or shallow gradients, it may not sustain a full size vortex. If the riffles are too close, too far apart, too tall, or if there is not enough energy available to the vortex, the vortex will not be formed properly and gold recovery will be reduced. If the slurry velocity is too high, extreme turbulence and the resulting scouring will also cause gold losses. For further information of the optimal design and operation of sluiceboxes see Appendix 3.

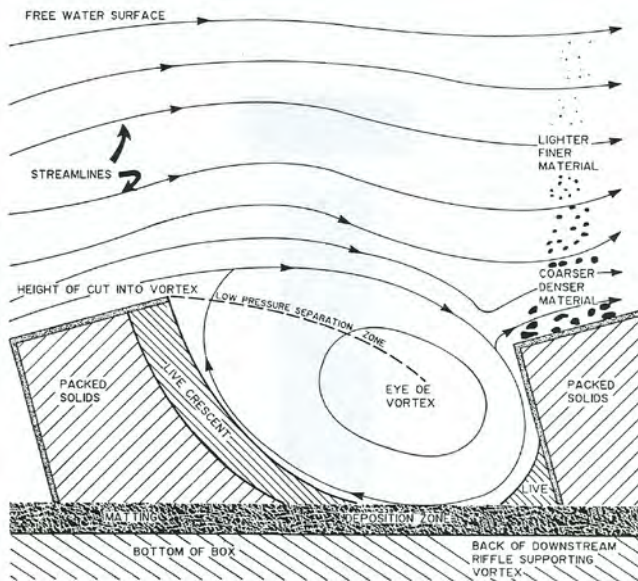

Figures 18 & 19 - Cross-section schematic and photo of one inch angle iron riffles in operation. Note: Due to their higher density, gold particles tend to segregate to the bottom of the slurry flow where they form a streamline that is diverted by a low-pressure zone into a riffle to form a vortex. At the bottom of this vortex gold particles are driven into the matting.

After several (8-40) hours of operation, the sluiceboxes are shut down, the riffles are removed and the concentrates are washed out of the underlying matting. Sluiceboxes can provide very efficient primary gravity concentration (95-99%) and reduce pay gravel volumes from 20,000:1 to 50,000:1. For example, a well-designed sluicebox operating at recommended parameter generally reduces 20,000 cubic yards of pay gravel to only 1 cubic yard of concentrate with 95-99% of the gold contained in the original pay gravels.



Figure 20 - Pre-Screened "Z" Box.



Figure 21- Low Profile Portable Sluice.

These modern sluiceboxes with vibrating screen decks are the primary means of concentrating the low grade alluvial gravels. They are simple, easy to operate, and have few moving parts. Well-designed sluiceboxes operating at recommended parameters can provide relatively efficient concentration (95% to 99% recovery efficiencies) at extremely high ratios of concentration (from 20,000:1 to 50,000:1).

9 - Background: Upgrading Sluicebox Concentrates

In mineral concentration processes, there is generally a tradeoff between recovery and grade. Sluicebox concentrate upgrading processes are no exception. High grade placer gold concentrates are generally produced by accepting lower recoveries, and it is the less easily concentrated gold that ends up in the tailings (or middlings). The limited concentrate volume of the batch type concentrators (long toms, live riffles and jigs) forces the grade up, as the placer gold crowds out less dense minerals. However, the less easily concentrated placer gold due to factors such as fine size, flatness or irregular shape, are commonly lost to the middlings or tailings.

Primary sluicebox concentrates are upgraded to a secondary concentrate in the Yukon using either small secondary sluiceboxes (long toms, figures 22 & 24) or with small dual cell hydraulic jigs (12" square, figures 26 & 27) or a combination of the two. The long toms are often a smaller version of the main sluice or may have a live bottom or water injected riffles. Conventional long toms generally produce a larger volume of secondary concentrates but are simple and effective. The highest grade concentrate is located in the first few riffles (figure 24). If there are nuggets in the concentrate, a section of the long tom should be fitted with coarse expanded metal riffles or a nugget trap to stop them from rolling off the end of the sluice.

Figure 22- Conventional Long Tom with Trommel.



Figure 23 - Lizotte Live Bottom Cleanup Sluice.



Figure 24 - Long Tom with Gold at Top. Riffles.



Figure 25 -Top View of Lizotte Live Bottom Sluice with Feeder, Vibrating Screen Deck and Live Riffles.



Note: Primary sluicebox concentrates are upgraded to a secondary concentrate in the Yukon using either small secondary sluiceboxes (Long toms) or with small dual cell hydraulic jigs (12" square) or a combination of the two

Dual cell hydraulic jigs are also commonly used to upgrade sluicebox primary concentrates and often produce a smaller volume of secondary concentrate than long toms. However jigs often lose finer (-50#) and flat gold particles but these can be recovered by installing a long tom at the jig discharge area. Jigs and their screens and steel ball ragging are difficult to clean and therefore are rarely cleaned completely. If left for long periods the steel balls and screens can rust together. Hydraulic jigs are powered by water pressure against a diaphragm fitted with springs. The volume of water and pressure to the diaphragms can be adjusted to affect the frequency and oscillation of the jig bed (figures 26 & 27).

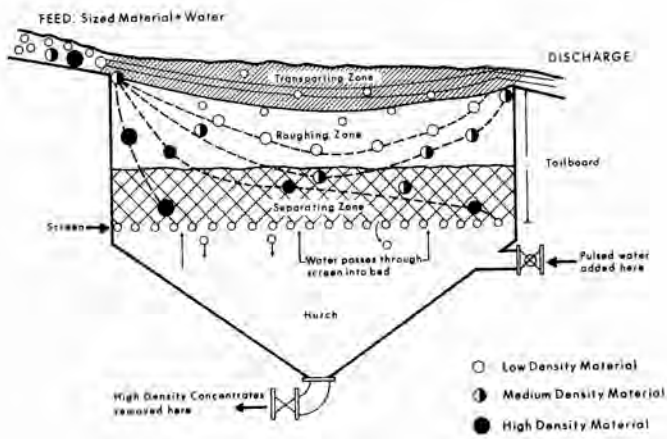

Figure 26 - Schematic of Typical Mineral Jig Operation – note the live bed of minerals flowing over the dense ragging which is supported by a screen at the bottom of the live bed (Burt, 1987).



Figure 27 - Typical Dual Cell Hydraulic Operated Jig with long tom at the discharge to recover fine gold typically lost by this type of jigging system.

To upgrade the secondary long tom or hydraulic jig a variety of methods are commonly used. Screening concentrates generally makes it easier to separate out gold from other waste minerals with almost any gravity recovery or upgrading process (figure 28). Generally the coarser gold sizes are hand-picked. Magnetic minerals such as magnetite and tramp iron are removed with hand held magnets. The secondary concentrates are then screened in preparation for the third (final) concentration stage. Large diameter gold wheels/spirals, shaking tables and hand panning are common methods to upgrade to a saleable gold product.

Gold wheels/spirals work best where the gold is bulkier (has a relatively high Corey shape factor >0.2 thickness/diameter ratio) and accessory heavy minerals are relatively low in density (S.G. <5). The rounded bulkier particles of gold tend to roll up the wheel and crowd out the accessory heavy minerals. However gold wheels have trouble recovering flat gold particles. Gold wheels are relatively inexpensive and use small amounts of electricity. It is usually better to use the larger diameter (greater than 1 m or 3 feet) than the cheap small diameter plastic wheels. Gold wheels have low throughputs and are often fed with a large spoon continuously by hand. Gold wheels with a large number of entrances (starts) in their spirals have a higher throughput but have dirtier concentrates (figure 29).

On the other hand, shaking tables work best where the gold is much flatter (flaky) and the accessory heavy minerals have high bulkier shapes (cubes and spheres). The flatter flakes of gold lie close to the table surface and pick up the table's oscillating motion more readily than the thicker accessory minerals, which are washed away from the gold by the (dressing) water washing over the table. However larger gold flakes may "surf" over finer high density minerals and end up in the middlings or tailings.

All shaking tables should have a feeder to ensure an even feed to the machines. An example of a simple feeder is shown on figure 33 and in Appendix 5. The feed material should be screened to at least 8# and often finer (to 16# or 20#) to get a good separation. Screening the feed material into several separate size fractions can improve the separation efficiency. Shaking tables generally do not work well for rounded gold particles (Corey shape factor greater than 0.4) (figures 30 – 33).

Gemini type shaking tables are often slower at processing gold concentrates than Deister type tables but they may offer a cleaner product depending on the type of material. The Keene ST1 shaker table used in this research was Deister type of table and was fitted with a set of rotating permanent magnets under the table to help separate out magnetic minerals. The Keene table actually worked better with some magnetic material in the feed and served a dual purpose as a very effective separator of gold and magnetics.

Gold wheels and shaking tables may complement one another. Some miners use a gold wheel to separate out the bulkier gold followed by a shaker table for the flakier gold particles.



Figure 28 - Left - Sweco Rotary Screen for Splitting Secondary Concentrates in Various Size Fractions – The coarse fraction for hand picking, medium and fine fractions for processing on the Gold Wheel possibly followed by processing on a Shaking Table.



Figure 29 - Large Diameter Gold Wheel - Bulkier gold particles travel up the Spiral to the Center and discharge out behind the center of the wheel.

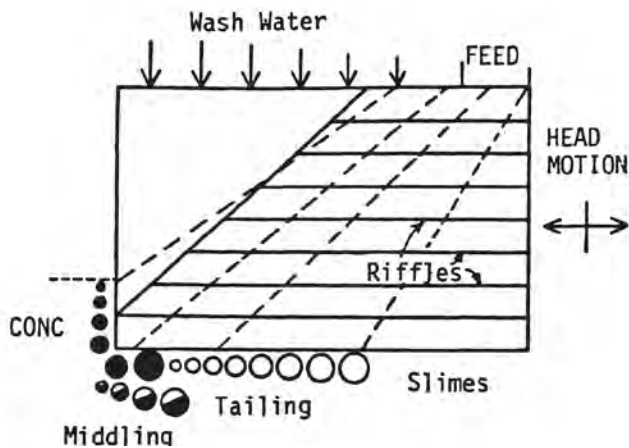

Figures 30 & 31 - Schematic (Burt, 1987) and Photo of Deister Type Shaking Table Deck: Particle paths of high density (dark) and low density (light) particles on a concentration table. Note the band of very fine gold on the top of the Keene table and the band of high density minerals in the middle of the table (middlings). In this photo there are no low density minerals to be directed to the slimes or tailings as shown in the schematic.

Figure 32 - Right - Gemini Shaking Table at University of Alaska – Fairbanks Attempting to separate flat flakes of placer gold from a middling (Concentrate Tailing) with abundant garnet.



Figure 33 - Keene ST1 Shaking Table with Rotating Magnetic Separators with Simple Feeder Mounted on Steel Base with Sand Bags.

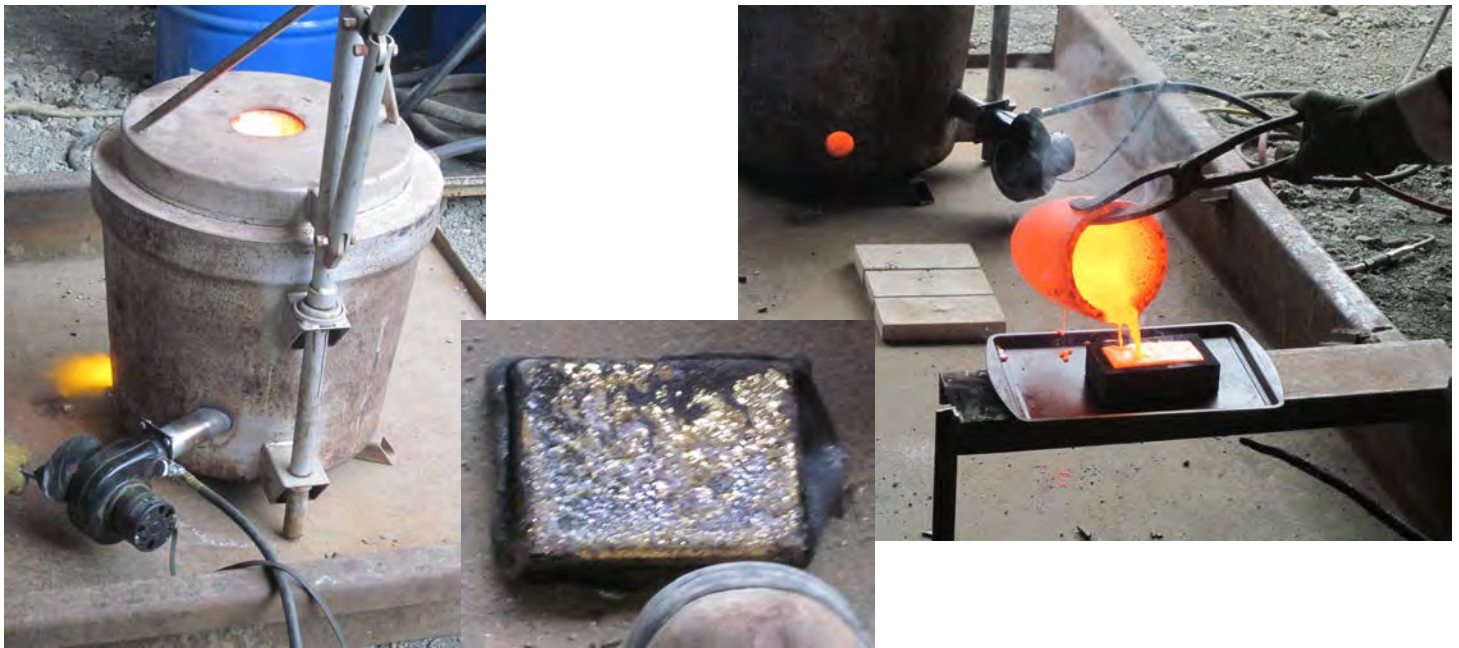

Figures 34, 35 & 36 - Smelting and Pouring a Dore Gold/Silver Bar.

10 - Background: Previous Research

George Poling and Ian Hamilton did some of the first significant placer gold recovery research in 1985 using a lab scale test program at the University of British Columbia. Their research helped to optimize the design and operating parameters for sluiceboxes. Dan Walsh (1985) from the University of Alaska, Fairbanks (UAF), developed the innovative radiotracer technique to test gold recovery equipment in the laboratory and assisted Alaskan placer miners at the UAF campus.

Clarkson (1989 and 1990) on behalf of the Klondike Placer Miners' Association continued the development of radioactive gold as tracers (radiotracer testing) in field and laboratory settings to examine and optimize sluiceboxes for the primary recovery of placer gold (figures 4 & 38-42). Clarkson did further research in 1993 and 1995 in the Yukon and British Columbia using radiotracers to evaluate and optimize placer drilling and sampling techniques. Clarkson (2010) also applied radiotracer testing in Alaska and in Guyana, South America to demonstrate improved gold recovery and to reduce/eliminate mercury in artisan mining of placer gold. All of Clarkson's research was publicly funded from Territorial and Federal agencies initially via the Klondike Placer Miners' Association and later via/ his company NEW ERA Engineering Corporation. The various reports were peer reviewed and published in mining journals. The technical reports have been well circulated in paper format and over the web; and are still in demand worldwide today.

In the 1980's and early 1990's several conferences and placer gold forums were held in Whitehorse, Dawson City, Fairbanks, and Vancouver to explain and promote various types of gold recovery technology. Since this period (1985-1995) there have been very few technical conferences and limited placer gold recovery research.

Figure 37- Right – Pilot Scale Sluicebox used by Clarkson and Peer (1990) to Optimize Sluicebox Riffle Operation.

George Poling and Ian Hamilton 1985 conducted the first significant placer gold recovery research in 1985 using a lab scale test program at the University of British Columbia (UBC).

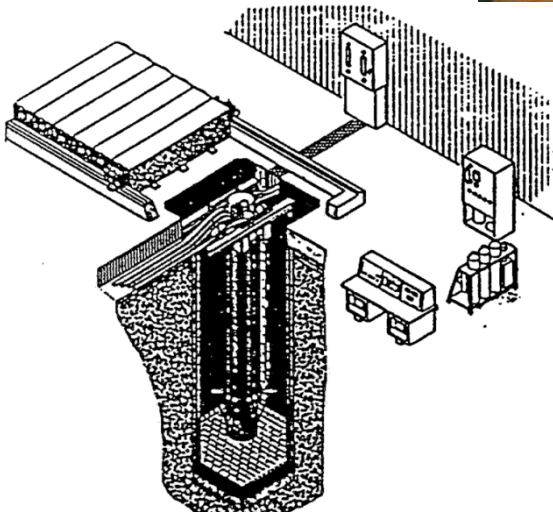

Figure 38 - Left - U of Alberta Slowpoke Reactor.

Walsh, a former professor at the UAF developed the innovative radiotracer technique to test gold recovery equipment in the laboratory.



Figures 39 & 40 - Radiotracer Testing of Placer Drilling Methods.



Clarkson continued the development of radioactive gold as tracers (radiotracer testing) in field and laboratory settings to examine and optimize sluiceboxes for the primary recovery of placer gold. Clarkson completed further research in the Yukon, B.C., Alaska and Guyana using radiotracers to evaluate and optimize placer drilling and sampling techniques.

Figures 41 & 42 - Mapping Location of Radiotracers in a Sluice Run.

Representative gold particles were sieved and mildly irradiated and added to feed gravels. At clean up, scintillometers were used to detect and map the low level X-ray and gamma ray radiation emitted by these tracers.



The effectiveness of any given section of riffles was easily diagnosed by the presence or absence of tracers.

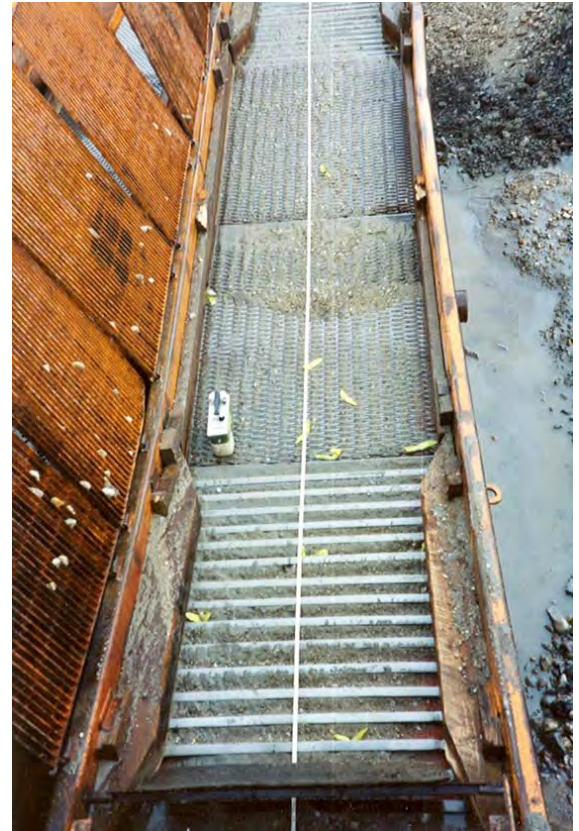

Radiotracers versus Conventional Testing:

Radiotracer testing is more statistically accurate. It is not subject to contamination or losses from subsequent recovery methods. It is able to locate recovery and loss areas (figure 42). The existing gold sizes/shapes and the degree of gold liberation must be replicated accurately. Gold losses are rapidly and easily estimated accurately but you aren't able to see the gold particles that are actually lost. It is also difficult to obtain and maintain nuclear tracer licensing.

Conventional Testing versus Radiotracers

Large samples must be processed with extreme care and avoid contamination of the samples with other gold particles. Conventional testing provides a brief snapshot of the gold recovery at any given time under highly variable conditions of material flow rates, velocities, pay gravel grades etc. (figures 43 & 44, 46 & 47). Conventional testing is much less accurate on a statistical basis. But there is no need to replicate the gold particle shape and degree of liberation. As a bonus, the researcher is able to obtain actual samples of lost gold for examination and further test work.

Figure 43 - Bags of Sluicibox Tailings Collected by Hand which are ready for processing on the author's very well tested testing sluice.



Figure 44 - Collecting Live Sluicibox Tailings samples with an Excavator.

Sluicibox tailings samples must be collected live in buckets directly from the end of the sluicibox to avoid segregation or pre-concentration of lost gold particles.

11 - Field Testing Methodology:

The primary sluiciboxes were examined in detail while shut down and operating. Several measurements were made including: dimensions of equipment; pay gravel feed rate; sands and slurry volumes; densities and velocities of flows (figure 45). Conventional testing of pay gravels often requires samples as large as ½ cubic meter and as large as 1 to 2 cubic meters for tailings samples. Samples must be live and taken directly from the sluicibox discharge as shown in figures 44 & 46. The samples were processed in the field with the author's testing sluice (figure 47).

Figure 45 - Randy Clarkson Measuring Slurry Density with a Hand Held Sample Cutter.

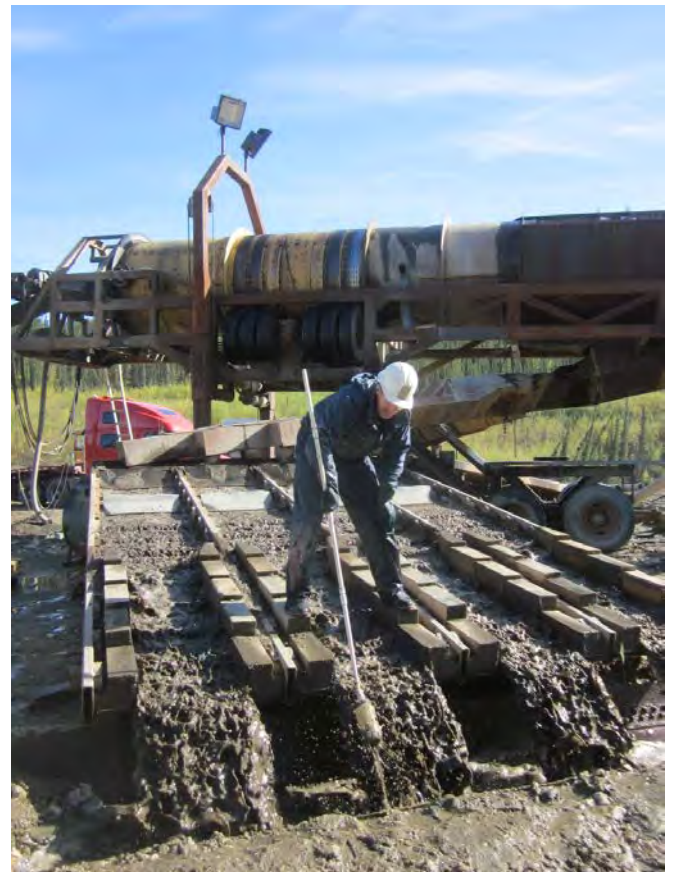

Figure 46 - Live Sluicibox Tailings Sampling.



Figure 47 - Gavin Clarkson Processing Sluicibox Tailings Sample on Author's Testing Sluice.



Figure 48 - Test Sluice Concentrates were hand panned to raw gold where possible or to a final concentrate for later lab testing. Gold samples were cleaned dried and weighed.



Several samples of tailings (middlings) from concentrate upgrading systems were sampled and processed on the author's testing sluice. In some cases the tailings from the test sluice was also saved to confirm the recovery efficiency of the author's test sluice.

Figure 49 - Dan Walsh Sampling Tailings from a Dual Cell Hydraulic Jig Cleanup System.



Figure 50 - Homemade Rod Mill.



Note: Do not use this design for a rod mill – use the design in the appendix.

Three grinding tests were conducted in the field in 2013 on cassiterite rich secondary concentrates using a homemade rod mill with 3 large rods/pins (figure 50). The homemade mill was temporarily mounted on a metal lathe to allow it to rotate. This equipment was not adequate for testing purposes but did indicate the potential for improvements in upgrading the cassiterite concentrates with grinding.

The mineral suites for each sample were examined and identified on site and later checked with an X-Ray Florescence (XRF) at the Yukon Geological Survey offices in Whitehorse. Without the XRF, it can be difficult to identify minerals in the field when they are very small grains (figures 51 & 52).

Figure 51 - Gavin operating XRF.

Figure 52 - Typical Output from XRF.

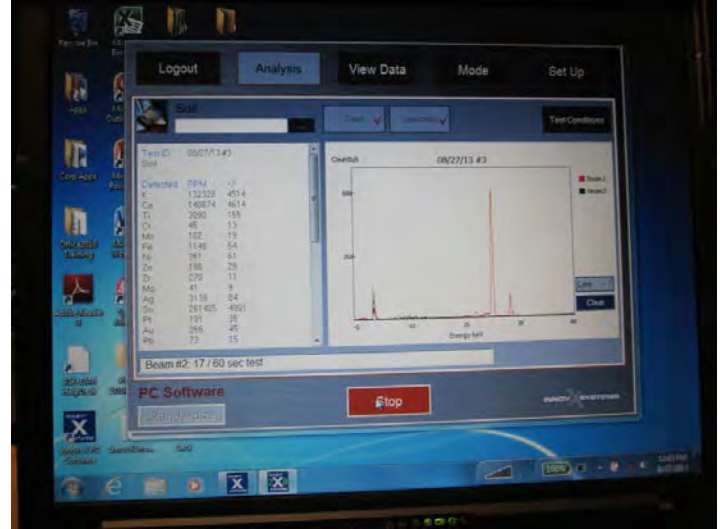
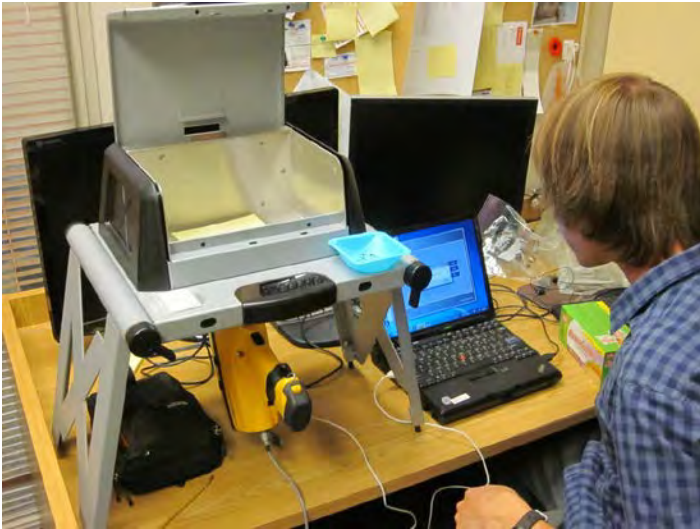

12 - Laboratory Testing Methodology:

The test sluice field concentrates, pay gravels, sluicibox tailings from field work as well as cleanup tailings and difficult gold concentrates collected from various gold rooms were all dried, bagged and saved. It is important to dry all samples to prevent any oxidization or cementing of samples.

The samples were weighed, spilt, sieved and processed in the UAF laboratory on three types of shaking tables: Gemini, Deister and Keene (figures 53 & 54). The tables helped determine any gold losses in the test sluice tailings, upgraded hand panned concentrates and were used to attempt to upgraded difficult concentrates (middlings) A few middlings samples such as those containing abundant pyrite responded well to tabling however most would require further processing.

Figure 53 - Gemini Table.



Figure 54 - Smooth Deck Deister Table.

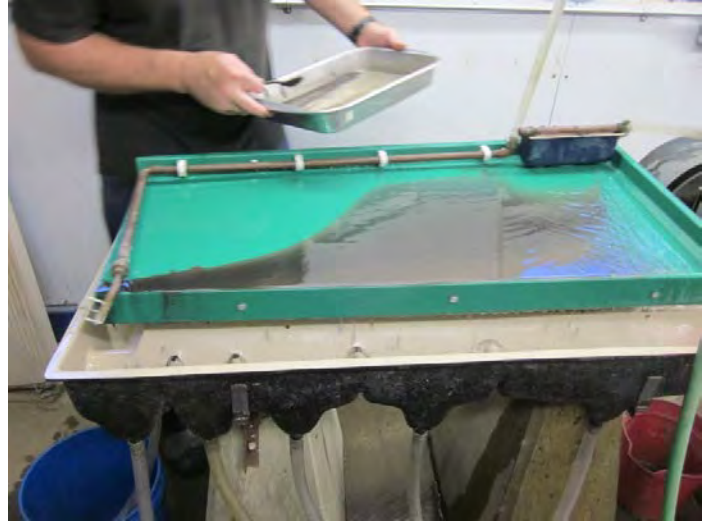

A total of 35 tabling tests were carried out. This included pan concentrates from pay gravel, tailings and concentrate tailings from field work in the summers of 2013 and 2014 as well as difficult concentrates (2nd hutch jig concentrates, cleanup tailings, magnetic tailings & smelter slag) and for upgrading the concentrates from other laboratory tests.

A total of 13 rod mill tests were conducted at the UAF lab in 2013 and 2014, three in the 2013 field season and another 16 rod mill tests were conducted in the field in 2015 using a portable rod mill designed by the author, figures 14-17 & appendix 6.

Figure 55 - UAF Rod Mill on Rollers.



Figure 56 - 8" Diameter Rod Mill & Rods.



Several tests were done on dried and screened concentrates and middlings using a low intensity magnetic drum separator (figure 58). However the results were disappointing and better results were obtained with powerful hand-held retractable magnets. All of the magnetic middlings processed had many gold particles which were trapped when the miners used hand-held magnets to demagnetize their concentrates.

Figure 57 - Rod & Ball Mills Used in Tests at UAF.



Figure 58 - Carpco Low Intensity Drum Magnetic Separator at UAF.



Some final gold samples which were difficult to clean were sent to commercial laboratories for fire assays (figures 59 & 60). Although not generally recommended or accurate for the analysis of pay gravels or tailings samples, fire assays were generally accurate methods for analyzing concentrates with a high percentage of fine gold. However assayers need to be warned they are going to assay high value products so that these samples do not contaminate their lab equipment for subsequent lower grade assays.

Figure 59 - Clay Crucibles Used.



Figure 60 - Electric Fire Assay Furnace.



13 - Field Program Results – Sluicibox Testing:

In 2013, thirteen placer mines were examined with detailed testing on ten sluiciboxes, pay gravels, tailings, and concentrates (figure 61). In 2014 an additional ten sluicibox tests were completed. The pay gravel geology, heavy mineral suite and gold losses were assessed to optimize gold recovery. Live tailings samples were taken and processed on the same field testing sluice.

Except for three operations requiring modifications, overall sluicibox gold losses averaged 0.8% (99% recovery). These results confirmed the more conservative estimates of 95% recovery derived from radiotracer testing in 1989 and 1990. The lowest gold losses occurred at sites employing a section of expanded metal riffles held tightly over unbacked Nomad matting and at least 3.6 m (12 feet) in length in combination with a narrower sluice run fitted with one inch angle iron at least 2.5 m (8 feet) long. Some operators used a wider 2.5 m (8 feet) length of hydraulic riffles at the same width as the expanded metal run instead of the one inch angle riffles.

Figure 61 - Data Summary Sheet for Sluiciboxes Tested in 2013.

	A	B	C	F	G	H	I	J	K	DS	DC	ES	EC
Geology/Minerals													
Glaciated Terrain	No	No	No	No	Yes	No	No	Yes	Yes	No		No	
Washability	Easy	Easy	Easy	Easy	Easy	Easy	Easy	Easy	Easy	Easy		Easy	
Heavy Minerals	Extreme	None	High	None	High	Low	Low	High	None	High		High	
Flat Gold	Extreme	normal	normal	Extreme	Extreme	normal	normal	Extreme	High	normal		normal	
Fine Gold	Extreme	Minor	Minor	Extreme	Extreme	normal	normal	Extreme	High	Minor		Minor	
Recoverability	Extreme	Easy	Moderate	Easy	Difficult	Easy	Easy	Moderate	Easy	Moderate		Moderate	
Processing													
Feeder	Yes	Yes*	Excav	Yes	Excav	Excav	Yes	Excav	Excav	Excav		Excav	
Surging	No	No	No	No	No	Slight	No	No	No	Yes		Slight	
Screen	Vibrate	Trommel	Vibrate	Vibrate	Vibrate	Trommel	Vibrate	Finger	Finger	Reverse	Spiral	Slight	Spiral
Opening (in)	0.50	0.75	0.75	0.63	0.75	0.50	0.50	1.00	1.00	0.75		0.75	
Distribution	Excell	Good	Fair	Excell	Excell	Fair	Good	Good	Good	Surging		Fair	
Angle Iron Riffles													
Slick Plate length ft	2.5	6.0	N/A	-	long	N/A	N/A	-	N/A	long	long	long	
Riffle Length (feet)	11.8	9.0	N/A	5.0	9.0	N/A	N/A	2.0	N/A	7.8	11.3	7.8	12.0
Velocity % optimum	121%	?	N/A	97%	?	N/A	N/A	117%	N/A	82%	113%	97%	107%
Water Flow % optimum	131%	159%	N/A	74%	52%	N/A	N/A	123%	N/A	33%	88%	70%	80%
Solids Flow % optimum	67%	103%	N/A	31%	46%	N/A	N/A	60%	N/A	17%	93%	44%	58%
Riffle Condition	Good/Agr	Scoured	N/A	Good- Botm	Fair	N/A	N/A	Good	N/A	packed	fair	good	fair
Expanded Metal Riffles													
Slick Plate length ft	8.0	3.4	4.7	6.0	3.0	2.0	1.7	-	2.0	long	N/A	long	N/A
Exp Length (feet)	20.0	13.7	11.5	14.3	9.0	6.0	2.0	7.0	14.3	4.3	N/A	4.3	N/A
Velocity % optimum	159%	114%	108%	99%	82%	61%	66%	117%	100%	95%	N/A	86%	N/A
Water Flow % optimum	167%	104%	110%	77%	52%	42%	45%	123%	96%	34%	N/A	78%	N/A
Solids Flow % optimum	90%	64%	77%	33%	46%	37%	31%	60%	63%	17%	N/A	49%	N/A
Riffle Condition	Fair/Agr	Excell	Excell	Good/Steps	Full/Loose	Part Packed	Packed Har	Excel	Full/Loose	Full Hard	N/A	Full/Loose	N/A
Hydraulic Riffles													
Slick Plate length ft	N/A	N/A	-	N/A	N/A	-	1.0	-	-	N/A	N/A	N/A	N/A
Riffle Length (feet)	N/A	N/A	7.8	N/A	N/A	2.3	3.7	13.3	10.4	N/A	N/A	N/A	N/A
Velocity % optimum	N/A	N/A	217%	N/A	N/A	122%	132%	234%	201%	N/A	N/A	N/A	N/A
Water Flow % optimum	N/A	N/A	221%	N/A	N/A	83%	91%	246%	192%	N/A	N/A	N/A	N/A
Solids Flow % optimum	N/A	N/A	154%	N/A	N/A	62%	62%	120%	125%	N/A	N/A	N/A	N/A
Riffle Condition	N/A	N/A	Good Loose	N/A	N/A	Fair	Excell	Excell	Full Hard	N/A	N/A	N/A	N/A
Parameters													
Total Water IGPM	3,002	3,816	943	2,041	917	494	1,417	1,050	1,113	83	835	185	961
Feed Rate Lpd3/hr	343	207	78	137	106	47	162	52	67	6	124	14	85
Estimate Head g/m3	0.37	0.74	0.41	0.34	0.25	0.63	0.93	0.81	1.62	0.48	0.48	0.48	0.48
Estimate Head \$/yd3	\$ 12	\$ 24	\$ 13	\$ 11	\$ 8	\$ 20	\$ 30	\$ 26	\$ 52	\$ 15	\$ 15	\$ 15	\$ 15
Estimate Tails \$/yd3	\$ 0.30	\$ 0.12	\$ 0.05	\$ 0.25	\$ 0.29	\$ 0.08	\$ 1.35	\$ 0.15	\$ 0.15	\$ 0.20	\$ 5.90	\$ 0.16	\$ 0.86
Estimate Losses	1.3%	0.3%	0.2%	1.1%	1.8%	0.2%	2.2%	0.3%	0.1%	0.5%	14.0%	0.5%	2.6%
No of Tests	1	2	2	2 static 2	2	2	2	1	1	1	3	3	2
	2.5%	0.5%	0.4%	2.3%	3.6%	lower grade 0.4%	4.5%	0.6%	0.3%	1.3%	more water / even feed 38.3%	1.0%	5.6%
Cleanup													
Hydraulic Jig	N/A	N/A	Yes	N/A	Yes	N/A	N/A	Yes	Yes	N/A		N/A	
Live Sluicibox	Lizotte	N/A	N/A	N/A	N/A	Lizotte	Lizotte	N/A	N/A	N/A		N/A	
Long Tom	Yes	Yes	Yes	Yes	Yes	Yes	Yes	Yes	Yes	Yes		Yes	
Tailings grade g/m3	1.1	1.9	54.8	0.1	45.7	200.0	0.7	4.5	8.9	164.4		164.4	
Tailings grade \$/Lyd:	\$ 36 variable	\$ 61 mixed	\$ 1,762 fines	\$ 2 fines	\$ 1,471 fines	\$ 6,430 nuggets	\$ 23 mixed	\$ 143 fines	\$ 287 fines	\$ 5,286 mixed		\$ 5,286 mixed	

Note: The average gold recovery was in excess of 99% (except for three operations).

In 2013, the highest gold losses occurred at a site using a reverse spiral drum with side and end sluices. It had gold losses in excess of 14% due to surging feed rates and a poor riffle design in the end sluice located downstream of the trommel discharge (figures 26 & 63). Those losses were reduced to 2.4% by retrofitting a better sluice design to recover gold lost in the tailings from the reverse spiral trommel. This was a significant improvement but still three times higher gold losses than the average conventional sluices operating under recommended parameters.



Figure 62 - Above – Surging in Sluice Run at the End of the Reverse Spiral Trommel.



Figure 63 - Right – Overloaded One Inch Angle Iron Run with High Gold Losses.

In 2014, two other mines with pay gravels high in clay had similar gold losses. One of these sites had hard packed one inch riffles and very short sluice runs (figures 64 & 65). The other site had steps between the riffle sections and too little flow over its one inch angle iron riffles (figure 66). After retrofitting both sluices the gold losses were reduced to less than 1%.

Figures 64 & 65 - Hard Packed Riffles in too Short of a Sluice Run.



Note: These losses were due to hard packed one inch riffles and too short sluice runs.

Figure 66 - Steps and Packed Riffles.



Figure 67 - Temporary Refit of Sluice.



Note: Steps, Jumps and Rooster Tails are too turbulent to allow excellent gold recovery in a conventional sluicebox. One inch angle iron riffles require twice as much slurry flow as expanded metal riffles. Whenever the two riffle types are located in the same width of run, one of the riffle types will either be overloaded or under loaded. Here the one inch angle iron riffles are spaced too closely together and do not have sufficient water to operate well. To address this, the one inch angle iron riffle spacing was widened to 90 mm (3.5 inches) on center (64 mm, 2.5 inch gap) and the sluice run sections with angle iron riffles were narrowed temporarily with wooden timber on the sides of the runs to increase the depth and velocity of the slurry over the riffles.

For conventional sluiceboxes, sluicebox gold losses averaged 0.8% and ranged from 0.1% to 2.2%. These results confirm nuclear tracer test results 95 – 99%. The best results came from plants fitted with at least a 3.6m (12 feet) length of coarse expanded metal in combination with either a 2.5 m (8 feet) length of angle iron or hydraulic riffles which were operating at optimum slurry volume, velocity and density and had frequent (daily) clean-ups of upper riffle sections.

In general the greatest natural factors influencing gold recovery:

- 1) Liberation of gold (from clays) in pay gravel (use of high pressure sprays on vibrating screen deck - or in extreme cases gravel pumps and/or high speed lined trommels);
- 2) Accessory mineral density, abundance and shape (requires more water and slurry velocity -more of an issue at the upgrading stage); and
- 3) Gold particle shape (flatness, porosity etc. – large very flat particles are the hardest to recover, fine gold in almost any shape is easier to recover)

Figure 68 - High Speed Rubber Lined Trommel to Scrub Clay-Rich Gravels.



Figure 69 - Rubber Lined Gravel Pump Breaks Down Clay.



The largest processing factors influencing gold losses are:

- 1) Surging feed to plant (avoid with excavator or belt feed);
- 2) Slurry volume, velocity and densities which are significantly lower or higher than optimum values for each type of riffle;
- 3) Sluice runs of insufficient length;
- 4) Long periods between clean-ups (several days) and
- 5) Use of alternative untested sluicebox designs



Figure 70 - Above - Good Design with Hydraulic Riffles at Top and Slick Plates between Sections of Coarse Expanded Metal Riffles.



Figure 71 - Left – Good Design with One Inch Angle Iron Riffles at Bottom of Sluices in Narrower Sluice Runs and Slick Plates between Sections of Coarse Expanded Metal Riffles.

Figure 72 - High Clay Gold Recovery System Trommel Scrubber & Screen



Note: The narrower one inch angle iron runs on the top and wider expanded metal runs which follow. This is a good design.

Figure 73 - Sluice Runs Too Short With & No Angle Iron or Hydraulic Riffles



Note: The very short sluice runs lead to high gold losses. This is a poor design.

14 - Field Program Results – Cleanup Concentrates:

Cleanup tailings from secondary upgrading equipment (jigs and long toms) (figures 22 & 24) averaged 35 fine grams per cubic meter (~\$1,135 per yd³). Clean-up tailings ranged from 0.07 to 1.9 fine g/m³, (~\$2 to \$60/yd³) for conventional long toms; from 5 to 55 fine g/m³ (~\$143 to \$1,762/yd³) for dual cell hydraulic jigs (figures 25 & 27); and from 1 to 200 fine g/m³ (~\$36 to \$6,430/yd³) for live bottom (Lizotte) sluices (figures 23 & 25). The extreme gold losses for the Lizotte concentrator were mainly due to the inability of its elutriator to recover coarse gold rejected by the fine vibrating screen. An elutriator is a vertical tube which uses a rising current of water to separate out lighter minerals from dense minerals which settle to the bottom.

Secondary upgrading systems with the lowest losses were conventional long toms operating at optimum values (figure 74 & 75). Long toms can produce greater volumes of concentrates but are simple and effective and when operated with sufficient water volume and velocity had the lowest gold losses. If there are nuggets in the concentrate, a section of the long tom should be fitted with coarse expanded metal riffles or a nugget trap.

Hydraulic jigs (figures 26 & 27) are commonly used to upgrade sluicebox concentrates and often do a reasonable job of concentrating primary sluicebox concentrates. Jigs often lose fine and flat gold particles, but these can be recovered by installing a long tom at the jig discharge area (figure 75). Jigs are difficult to clean and therefore are rarely cleaned completely for long periods. If left for long periods, the steel balls and screens will rust together. Most jigs have long toms for their tails but the long toms were usually not operating at optimum values (insufficient volume of velocity of water) and were cleaned very infrequently (once a year or once every 5 clean-ups).

Figure 74 - Typical Long Tom.



Figure 75 - Hydraulic Jig with Long Tom.



Note: Long tom at end of jig discharge to recover fine (-50#) gold lost in the jiggling process. This long tom is well set up with a slick plate in front but is too wide for the amount of water and solids that typically are discharges from a small jig.

The most difficult concentrates to upgrade had high proportions of high density minerals (cassiterite, galena, hematite, illmenite and garnet). Pyrite (fool's gold) is a very light cubic shaped mineral and is generally not difficult to separate from gold particles which are much flatter and heavier. Coarse (0.6 mm, 30#) very flat gold was the most difficult to recover whereas fine gold (150-74 microns 100- 200#) was generally not as difficult to recover and upgrade on a shaking table. Ground fine gold was always easier to recover on a shaking table.

15 - Laboratory and 2014 Pilot Scale Test Program Results:

Shaking Tables

Almost all of the concentrates tested in the laboratory and 2014 pilot scale test program were difficult concentrates which the miners involved were unable to upgrade to clean raw gold (at least without resorting to hand sorting/picking). The difficult concentrates consisted of 2nd hutch cleanup jig concentrates, cleanup jig tailings, cleanup long tom tailings, jig/long tom tailings, gold wheel tailings, gold wheel/Deister table tailings, hand sorting tailings, magnetic minerals and tramp iron with entrained gold, cemented concentrate tailings, smelter slag from gold dore refining and gold room spillage. Some test sluice tailings and gold pan tailings were also tabled to determine losses of upgrading these concentrates in the field.

The samples were from glaciated and unglaciated regions of the Yukon Territory. The gold from river deposits with shallow gradients and from glaciated areas was often very flat and occasionally irregular or botryoidal (grape-like). The most difficult concentrates contained abundant galena, abundant cassiterite, abundant garnet or a mixture of abundant magnetite, hematite and illmenite (black sand). A concentrate with abundant pyrite and minor magnetite was also tested but proved to be easy to process on a shaking table.

In 2013 and 2014 a total of 35 shaking table tests were conducted with the majority on the UAF Gemini table in the lab. All shaking table tests in the field were done with the Keene table. The shaking table test data is summarized in appendix 1. Clean gold recovery was compared to the smooth top Deister and to a Keene shaking table. Generally speaking, the Gemini table operated more slowly but in these tests produced a cleaner concentrate. However the Deister and Keene shaker tables were useful for producing both clean final concentrates and rougher concentrates for later processing.

The Keene ST1 shaker table was about 10 times cheaper than either the Gemini or Deister to buy at a cost of about US\$3,000. The Keene table also had a series of rotating magnets under its deck and doubled as a very efficient magnetic separator for placer gold concentrates during field trials. Indeed the Keene ST1 table worked much better if there were some magnetic minerals in the concentrates. Therefore, it would often not be necessary or advisable to remove all magnetic minerals prior to tabling the concentrates on the Keene ST1 table.

Three of the shaker table tests were done with the Keene table to separate out gold from the magnetics previously separated with hand magnets at the mines. One of these samples had rusted together and had to be ground in rod mill first. Another Keene shaker test was done to recover gold from smelter slag. Before tabling, the slag had to be ground in the rod mill first to liberate the gold particles which were melted into the slag.

All shaking tables were inefficient at concentrating placer gold in the difficult concentrates containing abundant cassiterite, galena and garnet. The tables operated slightly better with concentrates abundant in hematite and magnetite. Concentrates with abundant pyrite were easy to upgrade on a shaking table. Most concentrates had to be screened to a top size of at least 8# or finer (to 20#). Often several screen splits had to be made (-20+40#), (-40+50#), (-50#) or (-100#) to improve the recovery of clean raw gold.

The Keene table was used in the field to pre-concentrate samples prior to grinding in a rod mill (figure 76 & 77). The ratio of concentration ranged from 1:1 to 20:1. This greatly reduced the amount of samples that had to be ground and screened.

The main issue with tabling the difficult concentrates was that the coarser (+30#) flat gold particles would “surf” over the beds of compacted high density gangue minerals and end up in the table middlings or tailings. Some improvements were realized with screening the concentrates into different size fractions but many gold particles continued to “surf”. Often the -50# or -100# concentrates would table better than the coarser concentrates. When these fine concentrates were ground in a rod mill the fine gold particles became flatter and usually were easy to recover and clean on any shaking table.

Figure 76 - Keene Table Set Up.



Note: Sand Bags to Stabilize Table.

Figure 77 - Concentration of -50# Gold.



Note: -50# unground gold on top of Keene table.

Jig Tests

Many of the samples tested in the research program were 2nd hutch concentrates or jig tailings. However the operations with abundant cassiterite in their concentrates had not tried jigs. Therefore, one jig test was performed with a Denver 4x6 inch single cell jig at the UAF laboratory on a cassiterite concentrate salted with additional flat gold particles. A total of about 10 kg of concentrate was run through the jig for about 5 minutes. The jig ragging consisted of ¼ and ½ inch steel balls and coarse cassiterite.

The authors had hoped that the pulsating action of the jig bed would allow the flat gold particles to trickle through the ragging and into the jig concentrate. However, the test results were dismal with about 31% of the salted gold ending up in the jig concentrates, 58% in the jig ragging and 12% in the jig tailings. This jig like any other jig was difficult and very time consuming to prepare and cleanup after the test. A summary of these data is also provided in Appendix 1.

Magnetic Tests

Several tests were performed to separate out gold from the magnetics previously separated with hand magnets at the mines. When using hand magnets, gold particles are routinely trapped between magnetic particles or become attached to magnetic particles and are removed with the magnetic materials. Care needs to be taken, where magnetic material is abundant, so as not to entrap gold particles in clumps of magnetics. Rusted concentrate almost always encapsulates gold into the rusted agglomerates and requires grinding to liberate the gold, so that it may be concentrated and sold. Hand magnets play a large role in placer mine clean-up practices. They are a fine tool, provided the entrapment concerns noted above are considered. Cleaning and re cleaning mono layers of particles several times, when using a hand magnet, is the recommended practice.

In the UAF laboratory, a Carpco low intensity drum magnetic separator was used on six samples at various feed rates settings (figure 58). The samples had to be dried and screened to a top size of from 8 to 20# (mesh). The results with the magnetic drum were disappointing with lots of magnetic material reporting with the non-magnetic material and vice versa regardless of the speed of the feeder and the setting of the splitter.

In the 2014 field season, three tests on magnetic tailings were done with the Keene shaking table. One of these samples had rusted together and had to be ground in a rod mill first. The Keene table worked very well at separating the previously entrained gold particles from the magnetics. This is due to the combined shaking action of the table and the rotating magnets under the table. The ratio of concentration ranged from 8:1 to 33:1 with the final few grams of magnetic material removed with hand magnets. The Keene table was a much faster, easier and more reliable method of separating out gold from magnetic materials and did not require drying of the sample.

Grinding Tests

A total of 29 grinding tests were undertaken in the UAF laboratory in 2013 and 2014, with a homemade rod mill in the 2013 field season, and with a portable grinding mill designed by the author in the 2014 field season. A rod mill was chosen for grinding the concentrates due to the combination of impact and shear forces from the rolling rods which could produce coarse flattened gold and fine gangue (waste minerals). Rod mills are simple and easy to construct and maintain. They also preserve the gold particles and are easy to clean between tests. A small ball mill was used for one grinding test at the UAF labs in 2013 but did not appear to work as well as the rod mill.

Concentrates containing abundant heavy minerals such as garnet, galena, cassiterite, magnetite, hematite, or illmenite which could not be separated by tabling, jigging, panning or other physical methods were ground in a rod mill operating at 75-80% critical speed for 6 to 9 minutes. For the first ten grinding tests in the UAF lab, about 2 kilograms of concentrate was added to each 200 mm diameter by 200 mm (8x8") long rod mill. Some success was achieved at recovering clean gold particles on 30 and 50 mesh screens (typically 31-35% clean raw +50# gold). However, this high loading of solids created excessive attrition of the gold particles which reported as a low grade screen undersize product. When grind times at these loadings were increased, the result was more gold particles ground and lost to the screen undersize product.

It was only when the weight of the samples was reduced to 1 kg that the results improved and the gold particles were flattened instead of ground. Clean +50# gold recoveries generally rose to 71-78% in the lab with 1 kg sample weights. It would appear that the presence of too many waste minerals caused the gold particles to abrade. In field testing when a slightly longer (300 mm – 12”) mill was used the results were even better.

Figure 78 - A Graph of Clean Gold Recovery vs. Rod Mill Solids Load.

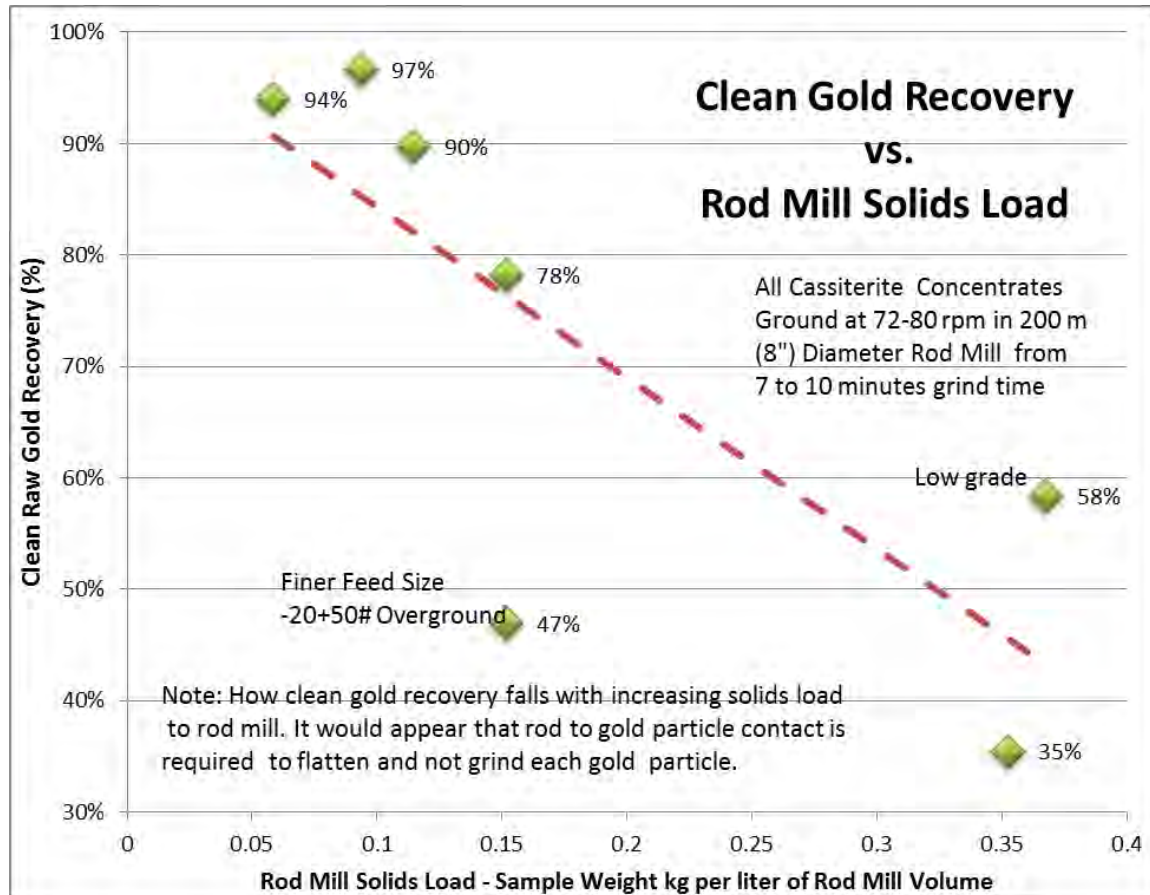

Note: The rod mill tests often had varying size distributions, rpm, grind times, rod mill lengths and various other factors to assess the impact of these parameters. More rod mill tests were done on cassiterite rich concentrates than any other and these data were selected to be as comparable as possible. All are in cassiterite, ground 7 to 10 minutes at from 78-80 rpm. A summary of laboratory data are included in appendix 2.

The high density waste minerals were preferentially ground and the gold particles were flattened as long as the mills were very lightly loaded and not operated for more than 7 to 9 minutes. The gold particles were easily separated by washing the ground pulp through a sieve (30, 50 or 70 mesh) (figures 85 & 86). A magnet was passed over the particles remaining on each screen leaving a produce of about 90 to 95 % clean raw gold. The remaining solids could easily be panned or tabled away leaving a concentrate of 95%-100% clean raw gold.

When the concentrates were ground with more solids in the rod mill or for longer than 9 minutes, some of the gold particles would be also be ground and would wash through the screens with the ground waste minerals. In the event that gold particles were ground to fine sizes, this fine material was collected and ground again at low loadings (200 to 500 grams) for 2 to 4 minutes and washed onto finer sieves (50, 70, 100 and 150# mesh). This second grind was done in the field in 2014 and increased overall clean raw gold recoveries in cassiterite rich concentrates from 77% to 97% and from 86% to 94% (figure 3 below). After re-grinding some the previously -50# gold was recovered on 50# screens due to the flattening effect of the rods in the rod mill.

Figure79 - Clean Raw -30+50# Gold.

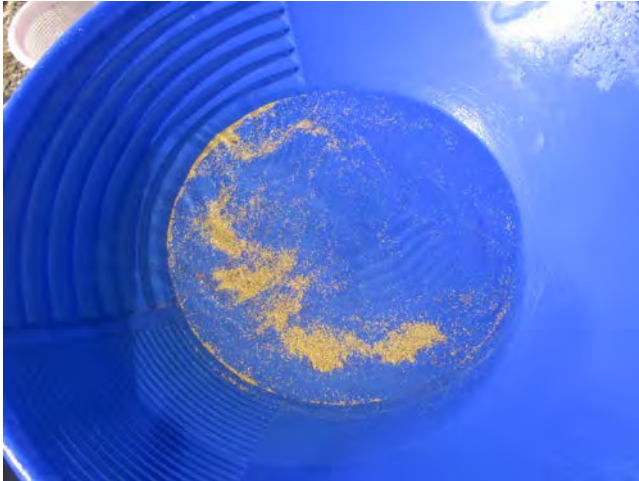
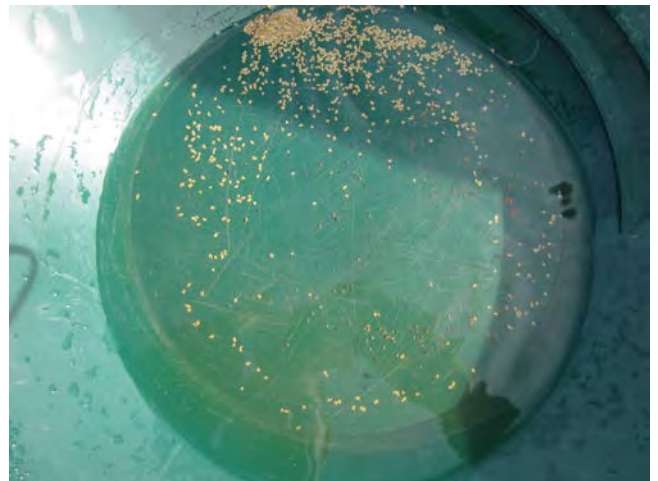

Figure 80 - Clean Raw -20+30# Gold.



Note: Both gold samples came from (1 kg) tests on cassiterite abundant concentrates.

During field testing in 2014 at mines with abundant galena, 93 to 95% of the gold was recovered as +50# clean raw gold after removing the magnetic materials

Figure 81 - Cleaned gold from mines with abundant galena in their concentrates.



Note: The vial on the upper right is the -50# screen undersize with typically about 1-5% of the total gold at 0.5 - 42% purity. The rest of the gold is clean raw gold. The small amount of impure gold concentrate could be blended into a pour or sample sold to a gold buyer since the rest of the gold is so clean.

Garnet is extremely hard and there was some concern that it would be difficult to grind without pulverizing gold particles. However clean raw gold recovery was as high as 76% even with the larger 2 kg sample during the first grind tests and this increased to as high as 86% in later lab trials and finally to as high as 99% in the 2014 field season grinding tests (figure 82).

Figure 82 - +8# Gold Nuggets & Flakes Recovered by Grinding a Concentrate with Abundant Garnet.



The worst recoveries of clean +50# raw gold were from mines with abundant magnetite, hematite and illmenite in their difficult concentrates. However only a limited amount of testing was done on this type of concentrate and most of the testing was done at high loadings (2 kg in the lab and 1.4 kg in the field tests) (figures 83 & 84 below). Some of these tests were further complicated by the presence of lead from bullets or old lead acid batteries in the concentrate. Lead is heavy and malleable like gold and therefore is impossible to remove with grinding and sieving (figures 85 & 86).

Figure 83 - Clean +30# Raw Gold.

Figure 84 - Not so Clean -30+50 Gold.



Note: These samples are from grind tests on Magnetite, Hematite, Illmenite abundant concentrates ground with too much sample (1.4 to 2 kg per test). The coarser size is clean but there is still some hematite with the -30+50# gold (right side). More grind tests with smaller sample sizes should be performed to improve clean gold recovery on this type of concentrate.

The effect of lead in concentrates can be seen in the following two figures. Lead is malleable and heavy like gold and impossible to clean with this grinding method. It must be removed by hand picking or chemical methods.

Figure 85 - Gold and Lead on Sieve.



Figure 86 - Close-up of Gold & Lead.



Figure 3 - Summary of Clean Gold Recovery from Various Difficult Concentrates.

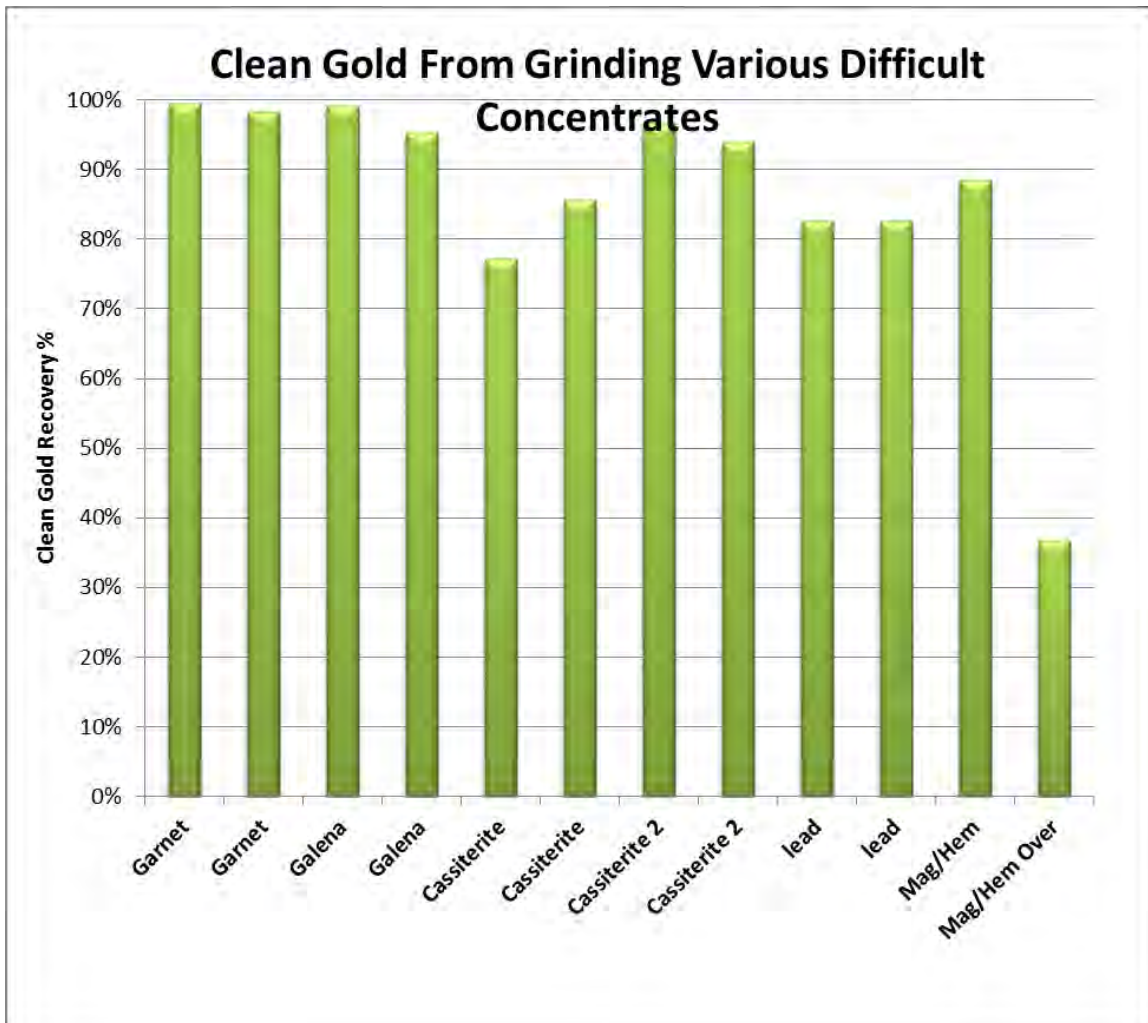

Note: Cassiterite 2 refers to the combined clean raw gold recovery after a second grind and sieving of the -50# material from the first grind tests. More testing with smaller samples would probably improve clean raw gold recovery of the magnetite hematite concentrates. The last bar is from a sample that was over ground.

The following figures show gold particles before and after grinding. The gold is flattened by the action of the rods and the particle surface is pitted due to other grains between the rod surface and the gold particle. The surface of the gold is also cleaned making it more valuable for jewelry. It is also more amenable to other methods of concentration such as leaching with cyanide or amalgamation with mercury.

Figures 87 & 88, 1 & 2 – Gold Sample Before and After Grinding in a Rod Mill.

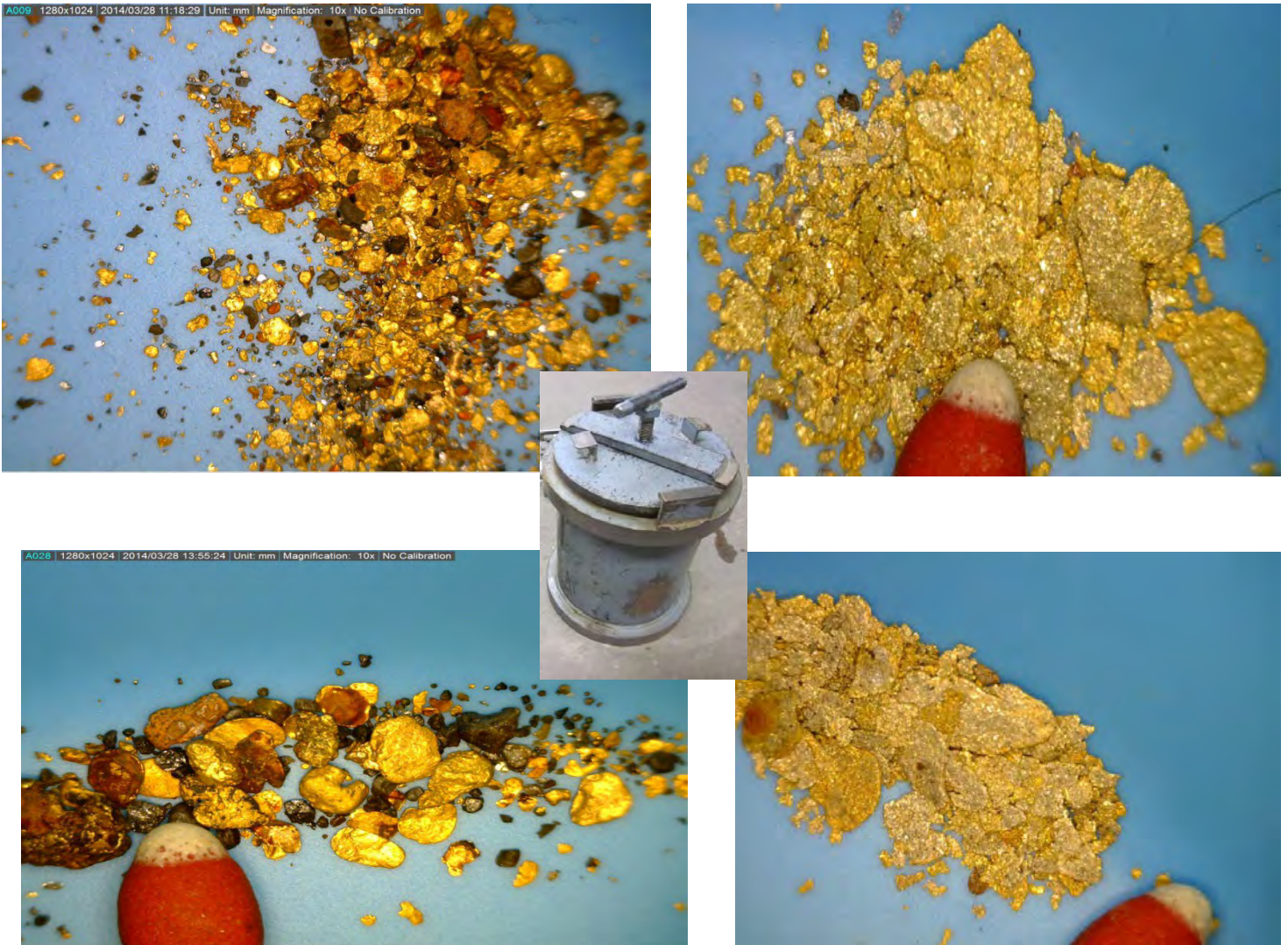

Note: Flat and pitted flakes of gold after grinding at low solids loads in a rod mill.

Over time, the rods and inside surface of the rod mill will have pits in the steel in filled with gold (figure 89 below). To remove and recover the gold, a 1 kg sample of quartz sand is ground in the mill for 10 – 15 minutes. Then the slimes can then be sieved and/or panned or tabled to recover the smeared gold.

Figure 89 - Rod with pits in filled with gold.



Figures 90 & 91 – Do NOT Overload a Rod Mill.



Do not overload the Rod Mill. Grind less than 1 kg (2.24 lbs.) of concentrate (middlings) for a 200 mm (8") diameter rod mill. If the rod mill is overloaded gold particles will be ground instead of flattened.

16 - References:

- AUSTIN, L., & TRASS, O. (1997). Size reduction of solids crushing and grinding equipment. Handbook of powder science & technology (pp. 586-634) Springer.
- BANISI, S., LAPLANTE, A., & MAROIS, J. (1991). The behaviour of gold in hemlo mines ltd. grinding circuit. Canadian Mining and Metallurgical Bulletin(Canada), 84(955), 72-78.
- BURT, R. (1987). Gravity concentration methods. Mineral processing design (pp. 106-137) Springer.
- CLARKSON, R.R, 1988, "Gold Recovery Project Feasibility Analysis". Prepared for the Klondike Placer Miners' Association with funding from the National Research Council and CANMET.
- CLARKSON, R. R., 1989, "Gold Losses at Klondike Placer Mines". Prepared for the Klondike Placer Miners' Association with funding from the Canada/Yukon Economic Development Agreement.
- CLARKSON, R.R.. and PEER, O., 1990 (B). An Analysis of Sluicibox Riffle Performance, (1989/90 Laboratory Analysis). Prepared for the Klondike Placer Miners' Association
- CLARKSON, R. R., 1990, "Placer Gold Recovery Research Final Summary". Prepared for the Klondike Placer Miners' Association with funding from the Canada/Yukon Economic Development Agreement.
- CLARKSON, R. R., 1993, "An Evaluation of the Gold Recovery Efficiency of Placer Drills Using Radiotracers". Prepared for the Klondike Placer Miners' Association with funding from the Canada/Yukon Economic Development Agreement.
- CLARKSON, R. R., 1995, "An Evaluation of the Gold Recovery Efficiency of Placer Drills Using Radiotracers (Part II)". Prepared for the Klondike Placer Miners' Association with funding from the Canada/Yukon Economic Development Agreement.
- CLARKSON, R.R., 1996. Radiotracers, A Revolutionary Method to Evaluate and Reduce Alluvial Gold Losses. Presented as workshops for the Guyana Geology and Mines Commission 1996 1997 and 2000; at the Second National Conference on Mining and Quarrying, Linden Guyana 1996; at the Northwest Mining Conference Short Course in Spokane, Washington, 1995; at Gold Recovery by Gravity Seminar, McGill University 1993; Field Conference on Placer Gold Deposits in the Cariboo Region 1992 and Atlin Region 1991; to 30 Soviet mining engineers from Yakutya, Russia in Anchorage, Alaska 1991.
- CLARKSON, R.R., 1997. An appraisal of Mercury Contamination prepared for the Environmental Protection Service and the World Bank.
- CLARKSON, R.R., 1998. An Evaluation of Drilling Techniques, 1998. A comparative evaluation of drilling techniques for deposits containing free gold using radioactive gold particles as tracers. Published in the International California Mining Journal, January 1998 pg 36-40 and Pathways 98, Vancouver, B.C., Canada, Extended Abstracts Volume, pg 227-229.

CLARKSON, R.R., 2010, "The Use of Radiotracers to Determine the Gold Recovery Efficiency of Sluicboxes". Presented at the AusIMM Gravity Gold Conference, in Ballarat Australia.

GREWAL, I., 20?? Introduction to Mineral Processing, Met-Solve Laboratories Inc.

GRIMWADE, M. (1992). The metallurgy of gold. *Interdisciplinary Science Reviews*, 17(4), 371-381.

LAPLANTE, A. R., BUONVINO, M., VELTMEYER, A., ROBITAILLE, J., & NAUD, G. (1994). A study of the falcon concentrator. *Canadian Metallurgical Quarterly*, 33(4), 279-288.

McCARTER, W.A., 1982. Placer Recovery – Presented at DIAND/KPMA short course in Dawson City

MITCHELL, C., EVANS, E., & STYLES, M. (1997). A review of gold particle-size and recovery methods.

NOAPARAST, M., & LAPLANTE, A. (2004). Free gold particles selection and breakage functions estimation. *Iranian Journal of Science & Technology*, 28(B6)

NUTTING, J., & NUTTALL, J. (1977). The malleability of gold. *Gold Bulletin*, 10(1), 2-8.

OFORI-SARPONG, G., & AMANKWAH, R. (2011). Comminution environment and gold particle morphology: Effects on gravity concentration. *Minerals Engineering*, 24(6), 590-592.

PETCH, N. (1954). The fracture of metals. *Progress in Metal Physics*, 5, 1-52.

POLING, G.W., HAMILTON, J. F., 1985 "Fine Gold Recovery of Selected Sluicbox Configurations" University of British Columbia

SILVA, M. A. (1986). Placer gold recovery methods Division of Mines and Geology.

VAN LOON, S., & BOND, J. D. (2014). Yukon placer mining industry 2010 to 2014. Yukon: Department of Energy, Mines and Resources.

WALSH, D.E., 1985 "Evaluation of the Four Inch Compound Water Cyclone as a Fine Gold Concentrator Using Radiotracer Techniques". Mineral Industry Research Laboratory, University of Alaska, Fairbanks.

WALSH, D.E., 1993 "An Investigation of the Performance of a Spiral Using Radioactive Gold Tracers". Presented at the SME Annual Meeting Phoenix, Arizona, 1992.

WALSH, D.E., 1988 "A Study of the Applicability of Particulate Radiotracers in Evaluating Placer Gold Jig Performance". Submitted to Faculty Grants Committee Office of the Vice Chancellor for Research UAF.

APPENDIX 1 - Summary of Data from Shaker Table Tests

Test	Material / Minerals	S.G.	Feed Size Range	Dry Wt kg	Tabled	Table Con kg	Table Con %	Date	Gold Dist +12#	Gold Dist +20#	Gold Dist +30#	Gold Dist +40 #	Gold Dist +50#	Gold Dist +70#	Gold Dist+ 100#	Gold Dist - 100#
Coarse Con	Cassiterite	4.157	-8#	4.276	Gemini					100%						
Processed on Gemini Table 2 times to cons																
Lots of large +14# and small -50# flat gold flakes saved Problems with large flat flakes surfing to middlings and tailings																
Fine Con L1	Cassiterite		-20#	9.509	Gemini											
Sieved at 40# to avoid surfing flakes 4.576 +40# 29%																
Extremely difficult to table 4.933 -40# 71%																
Ran -20#, reduced amplitude, used low water Produced a very clean con of -30# gold particles total 100%																
However the -16+30# flat gold won't penetrate cassiterite bed of materials on table & surfs to mids & tails ports																
Panned cons, all recovered gold is very clean -16+30# CSF >0.2m very difficult to demag																
Combined mids and tails and sieved at 40# Table -40# to some low grade concentrates med oval irreg flattened & fold flakes +30#																
same issue of coarse gold surfing into tailings ports: tried to table 2 times with same result																
Table -20+40#, much better action, no coarse flat no surfers to tailings, minor surfers to middlings - fairly dirty concentrates																
Grnd Con L7	Cassiterite		-40#	1.000	Smooth Deister											
Ball Mill -40# slimes table test Some concentration of gold at very low feed rates																
With shallower grade, faster shorter stroked have dirty con but probably most reporting to tails or mids																
Crs & Fn Coi	Cassiterite		-8#	9.312	Jigged	Denver 4x6" Lab Jig Test, Rotary valve										
Added gold 1.62 g gold various sc 2.218 kg 1/4 and 1/2" steel balls for ragging																
Jigging not successful - gold not penetrating ragging Conc 31% 23% 8%																
Gold everywhere in tails, hutch and ragging Rag bed 58% 53% 5%																
Tails 12% 10% 2% 0%																
Subtotal 100% 86% 12% 2% 0%																
Cassiter L1	Cassiterite	2.377	+20#	2.900	Total											
2nd cleanup tailings 1.028 +20# had more cassiterite and pyrite with minor tramp steel																
Tables easily, no surfing of coarse gold 1.844 -20#																
fine minerals are mostly garnet, fine middling contained -20+100# gold particles, 5%																
This is in addition to what was recovered in the field 95%																
Test	Material / Minerals	S.G.	Feed Size Range	Dry Wt kg	Tabled	Table Con kg	Table Con %	Date	Gold Dist +12#	Gold Dist +20#	Gold Dist +30#	Gold Dist +40 #	Gold Dist +50#	Gold Dist +70#	Gold Dist+ 100#	Gold Dist - 100#
Garnet L1	Garnet	2.161		1.556	Gemini											
Gold Wheel Tailings lg flakes surfing on finer lenticular mags & hematite																
Recombined all material for sieving at 16# 1.132 +16# 48%																
almost all magnetics were lenticular trap iron 0.424 -16# All gold appears to be ~ 16# 45%																
Ran -16#, re-ran mids 2 times, tails 1 time & re-ran cons 7% middlings																
All heavy minerals 50% magnetics & 50% red garnets Subtotal 100%																
Garnet L1	Garnet			8.104	Gemini											
Gold Wheel/ Deister Table tailings screened at 20# 0.424 +20# and into mids and tails - surfers are 14-28# and flat																
Some large flakes surfing on top to tails, 1.132 -20#																
more to middlings, panned to ~95% raw gold, very fine and large very flat flakes, sieved at -20 and 40# better but still surfers to mids & tails needs to be ground and re-tabled																
Garnet Tails	Garnet		-12#	7.369	Gemini			18-Feb-14	51%	45%	-20#					
Tabled on Gemini to remove gold and prepare for later grind tests Tables fair with most of the gold to cons																
Middlings re-ran on table and new cons combined with previous cons																
Garnet L1 S1	Garnet		-14#	1.872	Smooth Deister											
recovered most of large flat flakes (14#) and fine (100#) flakes - only two sizes of gold																
panning and hand picking is very difficult to do have some black sand pan tails - non-magnetic not saved																
Galena F2	Galena	3.132	-12#	5.476	Keene	0.199	4%	Not Ground Only	Tabled	N/A	N/A	N/A	100%	N/A	N/A	
Note: This is a glaciated steep gradient stream deposit with abundant galena that plugs sluicelox riffles and ends up in the concentrates.																
This sample was magnetic minerals & tramp iron from demagging the gold concentrates.																
The sample was very quickly reduced from 5.5 kg to 0.2 kg using the Keene table, the final separation was with hand magnets.																
SGMg/HeL1	Mag/Hem/Il	2.538	+8#	3.629	Gemini											
2nd Hutch Jig Concentrates -20# 1.971 13% 86% middle 1%																
Screened feed at 20# for tabling "+20 1.658																
-20# tabled well with large flat flakes surfing on fine hematite to middlings - re ran middlings - sieved at 40# to reduce surfers																
Tabled +20#, responded well with occasional rare surfer riding on magnetite/hematite fines bed																

Test	Material / Minerals	S.G.	Feed Size Range	Dry Wt kg	Tabled	Table Con kg	Table Con %	Date	Gold Dist +12#	Gold Dist +20#	Gold Dist +30#	Gold Dist +40 #	Gold Dist +50#	Gold Dist +70#	Gold Dist+ 100#	Gold Dist - 100#
SGMg/HeL2 Mag/Hem/II																
2nd Hutch Jig Con tails x2 added 0.496 of raw gold Keene																
Test on Keene Table, flattened slope & cut																
Keene Table tails to Gemini																
Gemini																
90%																
10%																
SGMg/HeF3 Mag/Hem/II 2.61 -12# 20.4 Keene 0.69 26% Not Ground Only Tabled N/A N/A N/A N/A 100% 44%																
This sample was from the end of the long tom downstream of a dual cell hydraulic jig - it was tabled only - not ground.																
The concentrate was upgraded 4:1 with the Keene table to grade of 44% clean raw gold which is direct smeltable.																
SC<g/HeL1 Mag/Hem/P 2.348 +20# 2.489 Gemini																
Cleanup floor tails - wet screened at 20# 0.677 +20#																
Tables very well, minor -20+30# particles 1.799 -20#																
Nothing in mids, combined mids & tails Zogas coarse have 50% magnetite, 49% hematite and 1% pyrite																
SGMg/HeL1 Mag/Hem/II 2.348 2.478 Gemini +16# 0.443 kg																
Cleanup Floor tails already been tabled - assumed barren -16# 2.033 kg																
added T2 = 1.4152 g of -50+100# gold																
Sieved at 16# recovered 1.396 g of salted gold																
CGMg/HeL1 Mag/Hem/II 3.519 3.563 Gemini tabl con 98% some large flat flakes surfed to 2nd pass middlings																
2nd Hutch Jig Concentrate +20# 1.77 tabl mid 2% middling 2nd pass dirty concentrate																
sieved at 20# -20# 1.397 tbl con +20# 0.2% mostly flat 20# particles																
30% magnetite, 70% hematite																
CGMg/HeL2 Mag/Hem/II Pannable cons but difficult due to flat round flakes - cleaned to ~80-90% clean gold																
2nd Hutch Jig Con tails x2 Keene Better dispersion and banding width, large flakes surfing 88%																
Gold T4 sample added 1.616 rg added Gemini Large flakes continue to surf into middlings - ran 2x 12%																
CGMg/HeL1 Mag/Hem/II Gemini																
Cleanup tailings gold pan tailings tabled +35#, con has lots of flat 50-100# gold particles																
Sieved at 16 and 30# mids had 4@100# and 8 @ 200# = added to cons																
Tabled -35# lots of -200# to 50# gold very fine not able to pan cons or separate easily on the Gemini																
panned mids +100to -200#, frequent gold particles not able to pan, some surfers																
panned tails 3@100# & 12@200# found & removed																
Test	Material / Minerals	S.G.	Feed Size Range	Dry Wt kg	Tabled	Table Con kg	Table Con %	Date	Gold Dist +12#	Gold Dist +20#	Gold Dist +30#	Gold Dist +40 #	Gold Dist +50#	Gold Dist +70#	Gold Dist+ 100#	Gold Dist - 100#
CGMg/HeL1 Mag/Hem/II 2.161 Gemini																
Cleanup tailings pan tailings																
Recombined barren + 35 & -35# to table with salter gold "T1" to -50+100# = 1.4222 g gold																
At high water there was too much gold in mids																
Reduced water & re-ran, probably <5% in mids <1%																
Retabled all tails a second time, not easy to separate fine gold on table																
Cannot pan out gold even with 30# +100# sieves																
EMg/He L1 Mag/Hem/II																
Test Sluice cleanup tails from processing of cleanup tails																
Tables well, test sluice tails had 12 @ 200# gold particles as losses																
Test sluice originally recovered 2.467 rg in summer of 2013																
0.0010 0.0%																
2.467 100%																
2.468 100%																
Pyrite F1 Pyrite 2.02 -12# 24.25 Keene 0.04 0.2% Not Ground Only Tabled 2% N/A 10% 28% 60% 100%																
This sample was from glaciated deposit with extremely high concentrations of coarse pyrite, it was not ground, it was tabled only.																
The sample tabled to almost pure gold even down to 100# size ranges and was easily cleaned later to >98% purity by panning.																
Pyrite L1 Pyrite/Mag 2.292 3.688 Gemini																
Cleanup tailings -16# 3.654																
Tables well,, large cubs of pyrite end up in cons																
Almost all material to tailings clean con of large cubes of pyrite and gold																
difficult to pan lg pyrite w/o screening Recovered 1@30# and hundreds of 100 to 400#																
final tails 2.618																
middling tails 0.421																
concentrate tails 0.615																
subtotal 3.654																
pitted surface botryoidal																

APPENDIX 2 - Summary of Data from Grinding Tests

Test	Material / Minerals	S.G.	Feed Size Range	Dry Wt kg	Tabled	Table Con kg	Table Con %	Grind Size	Grnd Wt kg	Grind Time min	Gold Dist +30#	Gold Dist +40 #	Gold Dist +50#	Gold Dist +70#	Dist Grnd Fines	Grnd Fines % Gold	Grnd Fines Wt Kg	Grnd Fines %
Galena F1	Galena	2.77	-8+50#	4.478	Keene	1.932	43%	-8+50#	1.035	6	71%	N/A	22%	N/A	0.7%	1.4%	0.81	78%
<p>Note: This is a glaciated steep gradient stream deposit with abundant galena that plugs sluicibox riffles and ends up in the concentrates.</p> <p>This sample was difficult to table to clean conc - prescreened at 50# prior to grinding - distribution of cleaned gold includes pre-screened -50# gold</p> <p>A total of 71% +22% = 93% was recovered as +50# clean raw gold - 5% of the gold was in the unground -50# split.</p> <p>The fine -50# ground fraction is very low grade 1.4% and unground fraction is low grade 5% for a concentrate but could be further upgraded with grinding.</p>																		
Galena F3	Galena	2.77	-8#	4.478	Keene	1.932	43%	-8#	1.103	6.667	66%	N/A	29%	N/A	4.7%	0.5%	0.91	82%
<p>Note: This is a glaciated steep gradient stream deposit with abundant galena that plugs sluicibox riffles and ends up in the concentrates.</p> <p>This sample was difficult to table to clean conc - not prescreened prior to grinding - total ground -50# is the same (5%) as was in the unground previous sample</p> <p>A total of 66% + 29% =95% was recovered as +50# clean raw gold.</p> <p>The -50# ground and unground -50# galena from previous sample could be collected, ground and sieved at 70# and 100# to clean the -50# fine gold.</p>																		
CassiterL01	Cassiterite	2.66	-8#	2.424	No	N/A	N/A	-8#	2.424	10	N/A	N/A	58%	N/A	42%	0.001%	2.25	93%
<p>Notes: The sample was coarse cassiterite concentrate with flat gold particles from a low gradient river placer deposit.</p> <p>A total of 58% of clean +50# raw gold was recovered with 42% of low grade (0.001%) -50# slimes.</p> <p>The sample was very low grade which may have influenced the results and grind sample may be too large for the small mill.</p>																		
CassiterL02	Cassiterite	2.66	-8#	2.882	No	N/A	N/A	-8#	2.882	15	N/A	82%	N/A	N/A	18%	0.002%	2.81	97%
<p>Notes: The same was coarse cassiterite as in L01 but had 0.1507 g of (-14+30#) gold added to existing fine gold particles.</p> <p>With the extra gold and longer grind time, a total of 82% of +40# clean raw salted and original gold was recovered.</p> <p>The better results are probably due to the addition of coarser gold, the amount of -50# slimes was slightly larger - 2.8 kg vs. 2.2 kg for previous test.</p>																		
CassiterL05	Cassiterite	2.66	-20#	2.322	No	N/A	N/A	-20#	2.322	10	11%	24%	N/A	N/A	65%	0.08%	2.24	96%
<p>Notes: This sample was fine cassiterite concentrate with flat gold particles from a low gradient river deposit.</p> <p>A total of 35% of the clean raw +40# gold was recovered with 65% as dirty -40# gold at 0.1% raw gold.</p> <p>There was too much material on the 50# sieve and so a 40# was used to obtain cleaner gold - need to grind longer?</p>																		
CassiterL06	Cassiterite	2.66	-20#	2.222	No	N/A	N/A	-20#	2.222	20	N/A	15%	19%	N/A	66%	0.07%	2.11	95%
<p>Note: This sample is the same fine cassiterite with flat gold as in test L05 but was ground twice as long (20 minutes).</p> <p>A total of 33% of the clean raw +50# gold was recovered with 67% as dirty -50# gold at 0.07% purity.</p> <p>The overall recovery has not changed with increased grinding, however the gold appears to have been ground finer.</p> <p>The amount of -40# slimes in L05 (2.24 kg) is similar to LO6 -50# fines (2.11 kg). Maybe too much material in the smaller rod mill?</p>																		
Test	Material / Minerals	S.G.	Feed Size Range	Dry Wt kg	Tabled	Table Con kg	Table Con %	Grind Size	Grnd Wt kg	Grind Time min	Gold Dist +30#	Gold Dist +40 #	Gold Dist +50#	Gold Dist +70#	Dist Grnd Fines	Grnd Fines % Gold	Grnd Fines Wt Kg	Grnd Fines %
CassiterL07	Cassiterite	2.66	-20#	1.000	No	N/A	N/A	-20#	1.000	20	N/A	N/A	71%	0.4%	29%	0.04%	N/A	N/A
<p>14-Sep-13 Note: This is the same fine cassiterite concentrate sample with flat gold as in test L5 through L9.</p> <p>1 kg of this cassiterite concentrate was ground for 20 minutes in a 6" by 6" diameter ball mill to see if recovery would improve.</p> <p>The recovery improved to 71% of 50# raw clean gold with a bit on gold on the 70# sieve (0.4%) and about 21% of the gold at -70# in low grade 0.04%.</p> <p>This grind had much less material but also a smaller mill 6"by 6" and used balls instead of rods.</p>																		
CassiterL08	Cassiterite	2.66	-20#	1.000	No	N/A	N/A	-20#	1.000	15	N/A	N/A	N/A	31%	69%	0.10%	0.91	91%
<p>15-Sep-13 Note: This is the same fine cassiterite concentrate sample with flat gold as in test L5 through L9.</p> <p>Note: Only 1 kg of the fine cassiterite sample was ground and for 15 minutes in a rod mill - less than 1/2 of normal sample size.</p> <p>Only 31% of +70# clean raw gold recovered - the sample was over ground considerably - try will less grinding time.</p>																		
CassiterL09	Cassiterite	2.66	-20#	1.476	No	N/A	N/A	-20+50#	1.000	10	N/A	N/A	N/A	36%	41%	0.00%	0.94	94%
<p>15-Sep-13 Note: This is the same fine cassiterite concentrate sample with flat gold as in test L5 through L9.</p> <p>Note: Only 1 kg of the fine cassiterite sample was ground and for 10 minutes - less than 1/2 of normal sample sieved at 50#.</p> <p>The recovery of clean +70# gold is still only 36% of the total mass including the -50# unground split, that increases to 47% of just the +50# ground product.</p> <p>The -70# material has a high percentage of the remaining clean raw gold 64% at a low gold grade 0.04% and is difficult to table.</p>																		
CassiterL10	Cassiterite	2.66	-8+40#	1.000	No	N/A	N/A	-8+40#	1.000	10	48%	10%	13%	7%	22%	0.01%	0.89	89%
<p>Notes: This sample of cassiterite concentrate was salted with an additional 0.142 g of friable gold particles for this test.</p> <p>The ground concentrate appeared over ground and had 29% of the gold distributed in the -50# size fractions</p> <p>Overall recovery of clean +70# raw gold was 78%, the -70# was about 0.01% gold. The salted gold was coarse (-14+30#).</p>																		
CassiterL11	Cassiterite	2.66	-8+40#	1.000	No	N/A	N/A	-8+40#	1.000	10	81%	8%	5%	N/A	6%	0.002%	0.93	93%
<p>Notes: This sample of cassiterite concentrate was salted with an additional 0.181 g of friable gold particles for this test.</p> <p>The mill speed was slowed to 40 rpm instead of 80 rpm resulting in a coarser grind, the salted gold was coarse (-14+30#).</p> <p>Overall recovery of clean +50# raw gold was 94%, the -50# ground material was very low grade (0.002%). Previous L10 test indicate that sample in L10 was over ground</p>																		
Cassiter F1	Cassiterite	2.64	-8#	54.19	Keene	11.89	22%	-8#	1.133	7	40%	N/A	21%	29%	10%	0.08%	0.93	82%
<p>Notes: This is an unglaciated low gradient river deposit with abundant cassiterite, minor tramp steel/illmenite and very flat gold flakes.</p> <p>These were Gold Wheel Tailings - they were tabled on Keene table to 22% of original weight, prescreened at 50# and ground for 7 minutes</p> <p>A total of 61% of +50# clean raw gold was recovered with 29% of the gold in a -50+70# at 12 % raw gold and 10% of the gold in a -70# fraction at only 0.1% purity.</p> <p>This fine gold fraction was combined with other -70# and -50# gold later and reground to clean the finer gold sizes.</p> <p>Regrinding of the -50# fines in F4 would increase overall recovery of clean raw gold to 85%</p>																		

Test	Material / Minerals	S.G.	Feed Size Range	Dry Wt kg	Tabled	Table Con kg	Table Con %	Grind Size	Grnd Wt kg	Grind Time min	Gold Dist +30#	Gold Dist +40 #	Gold Dist +50#	Gold Dist +70#	Dist Grnd Fines	Grnd Fines % Gold	Grnd Fines Wt Kg	Grnd Fines %
Cassiter F2	Cassiterite	2.66	-8#	0.927	No	N/A	N/A	-8#	0.927	7	37%	23%	17%	16%	7%	5%	0.42	46%
<p>Notes: This is concentrate from live bottom long tom 3/4 of the way down (middlings) 77% of the concentrate was clean +50# gold</p> <p>About 23% of the gold was -50# and ranged in purity from 8% (-50+70#) to 5% raw gold (-70#)</p> <p>The higher clean +50# gold recovery is probably due to the smaller sample and nature of the concentrate.</p> <p>Regrinding of the -50# fines in F4 would increase overall recovery of clean raw gold to 97%</p>																		
Cassiter F3	Cassiterite	2.66	-8+50#	0.76	No	N/A	N/A	-8#	0.578	7	N/A	N/A	59%	8%	2%	2%	0.40	69%
<p>Notes: This is concentrate from live bottom long tom 3/4 of the way down (middlings) 59% of the concentrate was clean +50# gold including unground gold.</p> <p>This sample is identical to the above but was pre-screened at 50# and this split was removed 86% of the screened concentrates was clean +50# gold</p> <p>About 10% of the gold was ground to -50# and ranged in purity from 7% (-50+70#) to 2% raw gold (-70#), the unground -50# gold was about 15% pure raw gold</p> <p>Regrinding of the -50# fines in F4 would increase overall recovery of clean raw gold to 94%</p>																		
Cassiter F4	Cassiterite	2.66	-8#	0.110	No	N/A	N/A	-50#	0.110	2	N/A	N/A	17%	37%	15%	28%	N/A	N/A
<p>Note: this is -50+70 ground and unground material from the previous 3 Cassiterite tests, all of the sieves including -70+100# had clean raw gold</p> <p>Therefore the total +100# clean gold recovery was 85% with 15% of the gold in the -100 # @ 28% clean raw gold</p> <p>Note also that this material was all -50# but after grinding there was 17% of the gold +50# due to the flattening effect of the grinding.</p> <p>Regrinding the -50# concentrates would result in recovering an additional 85% of the previous dirty -50# concentrates.</p> <p>The dirty -100# product may have been clean on a 150# screen which we did not have, but at 28% raw gold it was direct smeltalbe in any event.</p>																		
Garnet L03	Garnet	2.95	-16#	1.944	No	N/A	N/A	-16#	1.944	10	49%	12%	15%	N/A	24%	0.01%	1.87	96%
<p>This sample is coarse garnet with minor tramp iron, magnetite and hematite and has very flat flakes of gold.</p> <p>This sample had 76% recovery of +50# clean raw gold, but all sieves have lots of garnet to clean.</p> <p>Cannot pan the garnet away. The -50# split is only 0.01% raw gold. Need to grind next sample longer to obtain cleaner gold on each sieve</p>																		
Garnet L04	Garnet	2.95	-16#	1.976	No	N/A	N/A	-16#	1.976	20	10%	28%	11%	N/A	51%	0.01%	1.83	93%
<p>Notes: This is the same sample of garnet and coarse gold as in L03 but ground for 20 minutes instead of 10 minutes</p> <p>The total +50# clean raw gold recovery is only 49% with 51% of the gold in the -50# split at a low grade of .01% raw gold.</p> <p>Almost only gold on the 30 and 40# sieves, more +40# gold particles, size distribution appears smaller, less tramp iron & magnetics</p> <p>Increasing the grind time results in finer cleaner gold on the sieves but a lower overall gold recovery.</p> <p>Expect that the grind sample in both tests L03 and L04 is too large for the small 8x8" rod mill.</p>																		
Garnet L12	Garnet	2.95	-20#	1.000	No	N/A	N/A	-20#	1.000	15	N/A	N/A	69%	9%	22%	0.01%	0.89	89%
<p>This sample is coarse garnet with minor tramp iron, magnetite and hematite and has very flat flakes of gold.</p> <p>Note: This is a barren garnet concentrate sample salted with 0.416 g of "G" raw gold</p> <p>The total +70# clean raw gold recovery was 78% with 22% of the gold in the -70# at very low grade of 0.01%</p> <p>Checks at 8 and 10 minutes indicated more grinding needed, but perhaps 10 min would have been enough for 30& 40# sieves?</p>																		
Garnet L13	Garnet	2.95	-20#	1.000	No	N/A	N/A	-20#	1.000	40	86%	N/A	N/A	N/A	14%	0.004%	0.79	79%
<p>This sample is the same as L12 -coarse garnet with minor tramp iron, magnetite and hematite and has very flat flakes of gold. The speed of the rod mill as 40 rpm.</p> <p>The total +30# clean raw gold recovery was 86% with 14% in the -30# fraction at a very low grade of 0.004% raw gold. The grind time at low speed was 40 min.</p> <p>The mill speed was slowed to 40 rpm but due to the hardness of the garnet it had to be run for 40 minutes to get clean gold on a 30# screen.</p> <p>Gold on all sieves finer than 30# was very dirty and combined for fire assay.</p> <p>This result may be misleading as the salted gold added was relatively coarse (-14+30#) and the material was not well ground.</p>																		
Garnet F1	Garnet	2.95	-20#	22.3	Keene	2.24	10%	-20#	1.12	9	22%	N/A	19%	N/A	59%	95%	1.07	96%
<p>Note: this is an unglaciated low gradient river deposit with abundant garnet, minor magnetite/hematite and very flat gold flakes.</p> <p>Note: this is Gold Wheel/Dieseter table tailings with garnet - it was sieved at 20# to improve tabling and reduced to 10% of original -20# weight.</p> <p>The gold is clean after 9 minutes of grinding even in the -50# fraction for close to 100% of the gold at 90% clean, lead was the main contaminant</p> <p>Lead is impossible to separate from raw gold by grinding as both gold and lead have similar densities and are both malleable.</p>																		
Garnet F2	Garnet	2.95	-20#	7.13	Keene	7.13	100%	-8+20#	1.25	7	91%	N/A	9%	N/A	0.5%	0.2%	1.19	95%
<p>Note: this is Gold Wheel/Deiseter table tailings with garnet - It did not table well and was reconstituted to grind without prior concentration by tabling.</p> <p>This material is the -8+20# portion of the concentrate tailing and was ground for only 7 min and sieved at 50# and retabled to clean the ground minerals</p> <p>The coarsest fraction (+20#) was the dirtiest with lead at 72% clean raw gold, the -20+30# was clean and the -30+50# was only 6% clean raw gold.</p> <p>There was more lead in this size fraction (bullets and fragments of bullets from old timers) and that is why it was more difficult to clean.</p>																		
Garnet F3	Garnet	2.95	-20+50#	22.3	Keene	2.24	10%	-20#	0.44	5	N/A	N/A	58%	N/A	1%	42%	0.36	81%
<p>Note: this is Gold Wheel/Deister table tailings with garnet - it was sieved at 20# to improve tabling and reduced to 10% of original -20# weight.</p> <p>This is the same material as in the first garnet test but was sieved at 50# and the -50# removed prior to grinding</p> <p>Only 1% of the gold in the original +50# ground material was -50# and it was 42% clean raw gold.</p> <p>The -50# unground material was 90% clean raw gold. This test shows that much of the fine gold in the first test was already present before grinding.</p>																		

Test	Material / Minerals	S.G.	Feed Size Range	Dry Wt kg	Tabled	Table Con kg	Table Con %	Grind Size	Grnd Wt kg	Grind Time min	Gold Dist +30#	Gold Dist +40 #	Gold Dist +50#	Gold Dist +70#	Dist Grnd Fines	Grnd Fines % Gold	Grnd Fines Wt Kg	Grnd Fines %	
SGMg/HeF1	Mag/Hem/Il	2.30	-12#	18.40	Keene	1.36	7%	-12#	1.36	13	23%	N/A	13%	N/A	65%	18%	1.04	77%	
<p>Note: These are gold wheel tails from a glaciated deposit high in magnetite and hematite with minor pyrite and flattened gold particles Fines table on Keene table moderately well to low grade concentrate only but with high concentration ratio, gold wheel tails are flat gold which tables okay. This material was difficult to grind and resulted in a high proportion of high grade (18%) -50# fines - too much material in grinding mill Only 36% of the concentrate was +50# clean gold - too much material and the grind time was much too long.</p>																			
SGMg/HeF2	Mag/Hem/Il	2.65	-12#	42.34	Keene	1.764	4%	-12+50#	1.37	12	9%	N/A	28%	N/A	60%	0.9%	1.07	78%	
<p>Note: These are 2nd Hutch Cleanup Jig concentrates - screened at 50# for grinding The original gold in this jig hutch sample was much coarser than in the previous gold wheel tails. The concentrates tabled well and concentrated to 4% of the original volume. However the -50# unground and ground material was impossible to table. Only 37% of the gold was +50# clean gold, there was only 2% of the gold in the unground -50# concentrate at low concentration. The sample was much too large for this material and was over ground from 2% -50# to 62% of the gold distributed in the -50# ground & unground product. These samples should be ground again at very reduced volumes and reduced grinding times in the future.</p>																			
HBWC F1	lead	1.92	-8#	15.36	Keene	1.55	10%	-8+50#	0.742	6	33%	N/A	38%	N/A	15%	14%	average	92%	
<p>Note: This gold wheel tailings sample is from a high bench white channel deposit with lead and minor other high density minerals. This material tabled well on the Keene table with only 10% of the gold wheel tailings ending up as table concentrate for grinding. This material was ground for only 6 minutes and the concentrates combined with the concentrates from the following longer test.</p>																			
HBWC F2	lead	1.92	-8#	15.36	Keene	1.55	10%	-8+50#	1.48	10	33%	N/A	38%	N/A	15%	14%	average	92%	
<p>About 71% of the gold was concentrated to a +50# mixture of gold and lead (including the unground -50# material). This is equivalent to 84% of the original +50# gold concentrated to a mixture of gold and lead (about 50% lead, 50% gold) The lead had to be hand picked out of the concentrates as per usual, it cannot be separated by grinding or tabling. The larger sample grind size 1.48 vs 0.742 lead to a much longer grind time 10 vs 6 minutes and to overgrinding of the second larger sample. When the concentrates were combined it lead to the lower than optimal recoveries of clean +50# raw gold, abundant lead as also a problem.</p>																			
HBWC F3	tramp iron	3.16	-8#	3.94	Keene	0.455	12%	-8#	3.94	2	N/A	N/A	100%	N/A	0%	0%	N/A	N/A	
<p>This rusted concentrate tailings sample was busted into chunks with a hammer and then ground for 2 minutes to liberate the free gold particles. The final +50# concentrate was 82% clean raw gold due to the presence of lead in the original rusted concentrate. This test demonstrates the efficiency of the rod mill and Keene table for recovery of gold from rusted/cemented concentrates.</p>																			
Test	Material / Minerals	S.G.	Feed Size Range	Dry Wt kg	Tabled	Table Con kg	Table Con %	Grind Size	Grnd Wt kg	Grind Time min	Gold Dist +30#	Gold Dist +40 #	Gold Dist +50#	Gold Dist +70#	Dist Grnd Fines	Grnd Fines % Gold	Grnd Fines Wt Kg	Grnd Fines %	
HBWC F4	slag	N/A	-2#	3.20	No	N/A	N/A	-2#	3.20	8	21%	N/A	69%	N/A	11%	25%	2.70	84%	
<p>This sample was smelter slag from a botched pour with lots of gold in it, it was broken with a hammer and put in rod mill for 8 minutes. There were a total of 3 batches at 1.1 kg each ground About 90% of the total gold was recovered as clean +50# gold, some lead remained in the -30+50# portion (23% lead), and the -50# fraction was 25% raw gold which is a smeltable concentrate. This test demonstrates the easy recovery of gold from smelter slag using only grinding and sieving.</p>																			
HMG/He F1	Mag/Hem/Il	2.412	-16#	24.12	Keene	12.25	51%	-16+50#	1.19	9	8%	N/A	10%		2%	10%	N/A	N/A	
<p>This sample was gold wheel tailings from a concentrate high in pyrite, lead, magnetite and hematite with minor illmenite and flat gold flakes. The concentrate was difficult to table due to surfing of flat gold particles into middling ports, did two scavenger runs. Most of the gold (80%) was in the unground -50# fraction at 22% raw gold - only a small amount of gold was ground to -50# in size. For the -50# ground portion actual recovery of clean +50# raw gold with lead was 88%. The +30# fraction was 51% clean raw gold. The -30+50# fraction was 95% clean raw gold. To improve recovery of this very difficult sample it would be necessary to regrind the -50# unground and ground again and sieve at 70 & 100# to clean.</p>																			
HMG/He F1	Mag/Hem/Il	3.168	-8#	47.52	Keene	1.358	3%	Not Ground	Only Tabled		35%	N/A	N/A	N/A	65%	12%	N/A	N/A	
<p>This sample was magnetics in a pail - sieved at 20# tabled separately at high throughput on Keene table Reduced the 47.5 kg to 1.4 kg on table and to 0.4 kg with hand magnet, the +20# were hand picked The -20# cons were split and hand picked due to presence of abundant lead.</p>																			

3.1 WATER AND FEED RATES

Pay gravels containing a high proportion of high specific gravity minerals such as magnetite, or a high percentage of clay are susceptible to riffle packing. Extreme gold losses occur when a sluice's riffles become packed because the gold is unable to get through to the matting.

Pay gravel feed rates of 20 cubic meters/hr (8yd³/hr/ft) and water flow rates at 40 l/s per meter of sluice width (200 USgpm/ft) have been recommended for expanded metal riffles by Poling (1986, 1987) and Clarkson (1989). Feed rates for angle iron riffles only were often increased up to a maximum of 40 m³/h/m (16 yd³/hr/ft) without significant gold losses. Pay gravel feed rates that exceed these recommended values were one of the greatest factors contributing to gold losses, Pay gravel feed rates below recommended values may improve gold recovery very slightly.

Water flow rates were less critical to gold recovery provided there was at least 40 l/s per meter of sluice width (angle iron riffles require about 80 l/s/m, 400 USgpm/ft). Water flows were often increased up to 60 l/s/m without noticeable gold losses. However, the excessive water flows (120 to 220 l/s/m) and extreme velocities (3 to 5 m/s) in some sluiciboxes were partly responsible for reduced gold recovery.

3.2 RIFFLE DESIGN

Clarkson (1989) recommended the use of one inch (25 mm) angle iron riffles to retain gold particles coarser than 1 mm (14 mesh) and expanded metal riffles to retain gold finer than 1 mm. The addition of a steeper and narrower section of angle iron riffles to the end of expanded metal sluice runs generally increases the recovery of +1 mm gold and improves overall gold recovery.

When expanded metal riffles are operated properly, they divert gold particles into their multiple vortices and drive them into the matting. Optimum slurry velocities for the expanded metal riffles section depend on the material sluiced but generally ranged from 1.5 to 2 m/sec. Expanded metal riffles are shallow riffles that are sensitive to scouring and the resulting coarse gold losses when they are subjected to surging or excessive water flows and/or steep sluicibox gradients. Water flows and slurry velocities below recommended values (greater than 40 l/s per meter of sluice width) and feed rates greater than recommended values (less than 20 m³/h/m) resulted in riffle packing and extreme gold losses in all size ranges.

Doubled expanded metal riffles are not recommended because the bottom layer of expanded metal packed and prevented gold particles from penetrating into the matting. The use of doubled expanded metal riffles contributed to the extreme gold losses (71% loss) at one mine tested in 1989.

One inch (25 mm) angle iron riffles required higher slurry velocities (1.8 to 2.2 m/s depending on material), higher water flow rates (about 80 l/s/m) and could often operate at higher feed rates (up to 40 m³/h/m) than expanded metal riffles. Angle iron riffles should have a 40 to 60 mm gap (depending on the material sluiced) and be tilted at 15 degrees upstream of the sluicibox's vertical in a sluice run. Packing and extreme gold losses were often observed when any of the following conditions occurred: low

slurry velocity; narrow gaps between riffles; excessive feed rates; insufficient water flow; and riffles larger than 25 mm.

Flat bar riffles are not recommended for the recovery of gold particles smaller than 4 mm (6 mesh) because they create excessive turbulence and reduce the vertical segregation of gold particles. The material rejected by a flat bar's vortex is launched up to the top of a turbulent slurry column instead of on to the next riffle. This severely reduces the opportunity for gravels and anything except very coarse gold nuggets to enter the riffles. Only two of the mines tested recovered any tracers in their flat bar riffle sections. Flat bar riffles may be suitable for a coarse (+6 mm) nugget trap.

All riffles must be held down tightly on porous matting such as "Nomad" to avoid gold losses through scouring. Riffle sections that had warped above the matting did not recover tracers and were a common cause of gold losses. One mine increased its gold recovery by 10% simply by straightening its warped expanded metal riffle sections and installing them correctly.

Unbacked Nomad matting appears to be the best matting in common use because it does not interfere with vortex formation, most of its volume is available for gold storage, it does not release trapped gold particles in an operating sluicibox and it is easy to clean. Cocoa matting and Astro Turf are not recommended because of their limited storage capacity and difficulty in cleaning.

Monsanto matting is not recommended because its long needles disrupt the formation of regular large vortices and result in packing. Field-testing results indicated that cocoa matting and Monsanto matting were unable to retain fine (0.30 mm, -48 mesh) gold particles as effectively as Nomad matting.

By 1990 almost all the Yukon placer miners had already implemented recommendations from the 1989 test program including the use of unbacked Nomad matting, coarse expanded metal and 25 mm angle iron riffles. None were using doubled expanded metal riffles and very few were using cocoa matting or Monsanto matting. By 1998 almost all of the Guyanese placer miners were using coarse expanded metal riffles over Nomad matting.

3.3 PRE-SCREENING

When pay gravels are screened before sluicing, gold recovery is improved dramatically, much less water is required for sluicing, barren gravels are eliminated from the sluicibox feed and riffle wear is significantly reduced. Pre-screening eliminates the need for a triple-run box and the corresponding problems in allocating fine gravels and water to the various sluice runs.

Screens also improve washing by breaking up clumps of clay and cemented particles. Inadequate washing is a very common cause of gold losses. The Derocker is a reliable moving deck grizzly-feeder which does a good job of washing and rejecting coarse boulders. It can be fed with a bulldozer providing additional wings are added to its entrance. Its main limitation is its feed rate (generally less than 100 m³/h) and its coarse under-size (50 mm).

Trommel screens are very good at scrubbing pay gravels rich in clays or cemented gravels but can be costly and relatively inefficient screening devices. The feed rate must be controlled with a manned monitor or by short feeding cycle times. The long

gradient required of a trommel screen also requires high feed ramps or conveyors. A vibrating screen has a higher throughput, lower height requirements and lower capital costs than a trommel. Two or three decks can be stacked on top of each other and result in very efficient, high volume screening.

The impact of large boulders can be reduced by sorting them out of the feed where possible, loading them onto a sloped stationary dump box instead of directly onto the screen, using a heavy duty screen deck, and by armoring the top screen deck with rubber or rubber coated screen panels.

Figure 92 - A comparison of riffle performance:

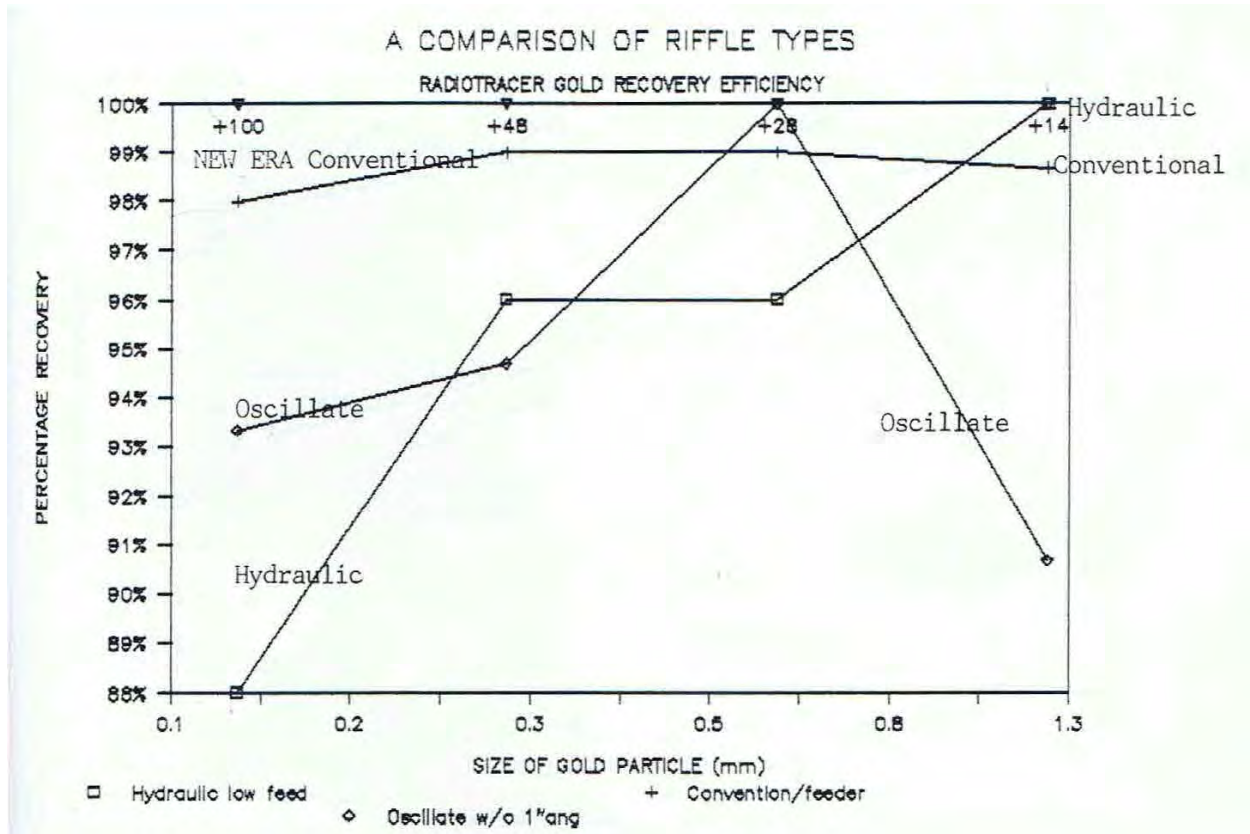

Figure - 92 These data are a compilation of several nuclear tracer tests and show that a combination of expanded metal and one inch angle iron riffles mounted firmly over unbacked Nomad matting (NEW ERA Conventional) are the most efficient riffle system for a wide range of gold particle sizes.

Recommendations for Sluicboxes:

- Stick to conventional sluicboxes
- Fit with slick plates ahead of at least 12' (length) of coarse expanded metal
- Combine with either a narrower sluice (1/2 width) with one inch angle iron riffles
- Or a similar width sluice with hydraulic riffles
- Operate at optimum slurry volume, velocity and density
- Do frequent (daily) clean-ups of upper riffle sections (even a 3 to 4' length at the top)
- Sluicboxes with excellent gold recovery DO NOT vibrate – oscillate – spin – rotate or have flashing lights – neither do they go bump in the night.

APPENDIX 4 – Recommended Difficult Concentrate (Middlings) Upgrading Procedure

Figures 93-96



- 1) Pre-concentrate very low grade gravels on a long tom or hydraulic jig



- 2) Pre-concentrate middlings on a shaker table to reduce the volume prior to grinding



- 3) Grind up to 1 kg (2.24 lbs.) of tabled concentrate with 50% water and 40% rod volume for 6-10 minutes at 72 rpm in a 200 mm (8" diameter by 12") rod mill.

Don't Overload the Rod Mill it won't work!

Screen the ground up concentrate on 20, 30, 50 or 70 mesh sieves. Use a magnet to take out the magnetics. If the gold on the 30 or 50 mesh screen is 90% clean pan the sample to clean it further. If the gold on the screen is dirty then reduce the weight of the sample ground or increase grind times. If there is a lot of gold in the screen undersize reduce the sample weight or reduce grind times.



APPENDIX 5 - Feeder for Keene ST1 Shaking Table

Figure 97 - Simple Feeder for Table



Note: Every shaking table works best with a feeder. This is a simple design using a plastic funnel, a small piece of drilled aluminum plate to support the funnel, a modified PVC pipe connector to lower and raise the funnel to decrease or increase the feed rate, and most importantly a thin stainless plate that fits snugly in the corner of the table underneath the funnel to prevent wearing a hole in the bottom of the table. Keep a small amount of water dripping into the funnel to keep the material flowing. **Do not operate this feeder without a stainless steel plate on the table surface or you wear a hole thru.**



Figure 98 - Aluminum Plate Support

Note: This support design will vary with each type of table it is attached to. It is approximately 178 mm (7") x 127 mm (5") and 6 mm (1/4") thick.



Figure 99 - Stainless Steel Deck Protector

Note: Don't forget this item or your table won't last the day. This is for a Keene ST1 table. It measures about 152 mm (6") long by from 76 mm (3") to 89 mm (3.5") wide. The edges should be custom ground so that it has a snug fit in the corner of the table but can be gently pried out to clean underneath it occasionally.

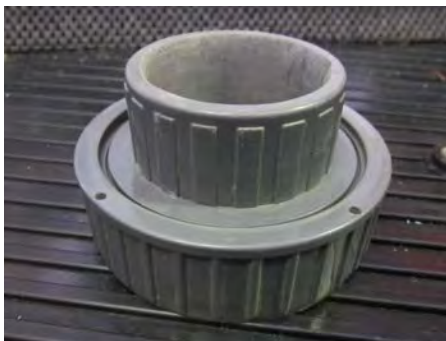
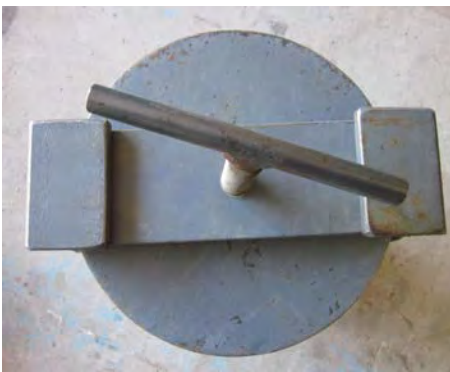

Figure 100 - Height adjuster.

Note: This is an adapted 50 mm (2") PVC pipe connector which has been cut shorter and the center reamed out with a file to hold and to raise and lower the funnel and thus adjust the feed rate to the table. Almost any threaded fitting that you can raise or lower easily will work for this purpose.

APPENDIX 6 - Specifications for Fabricating and Operating Pilot Scale Rod Mills

Figures 101-107 - Detailed Photos of 200 mm (8x12") Rod Mill



Note: This rod mill is 200 mm (8") inside diameter and 300 mm (12") long inside the mill.



Note: The original pulleys need to be changed from a 6" to a 4.5" on the gearbox and from 1.75" to a 4" diameter adjustable pulley on the motor to increase the speed from 25 rpm to 72 rpm (for 200 mm, 8") rod mills.

Note: A 200 mm (8") mill needs the following 292 mm (11.5") long cold rolled steel round rods: 12 mm (1/2") = 17 only; 18 mm (3/4") = 14 only; 25 mm (1") = 9 only

A large diameter rod mill could be used provided it is 1.5 times as long as the diameter the rpm is adjusted, and the portable cement mixer is able to support it.



Note: This is a close up of the 24 mm metric female adaptor which screws onto the horizontal drive of the MultiQuip MixNGo Model MC3PEA two cubic foot portable cement mixer. It has to be machined. The threaded end is welded onto the back of the rod mill as shown in the center photo.

APENDIX 6: Acknowledgement of Funding

This research project could not have been completed without the funding from the following three agencies: Canadian Northern Economic Development Agency; Strategic Investments in Northern Economic Development; and Yukon Research Center.

The authors would like to acknowledge funding from these agencies:



Canadian Northern Economic
Development Agency

Agence canadienne de
développement économique du Nord



Cold Climate Innovation

YUKON RESEARCH CENTRE • Yukon College